

Castle Series LED Downlight



Fix Angle



Φ79

Φ108

Φ148

Φ190



Adjustable Angle



Bridgelux COB

Low UGR <19, High Lumen Output



Double Reflector Control

Clear Lens and Diffused Lens Available
60° Cut-off Angle and Silver Finish



Variety of Light Colour

2700K / 3000K / 3500K / 4000K / 5000K
CRI >80 or 90 for Option

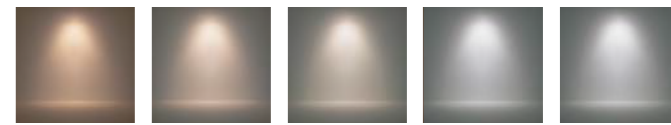

2700K

3000K

3500K

4000K

5000K

Easy Installation

Super Narrow Trim





GJCAS-9W-F

LED Power: 9W
CCT: 2700K/3000K/4000K
CRI: 80 or 90
DC Voltage: 17.8V
DC Current: 500mA
Beam Angel: 24° 38° 55°
Dimension: $\Phi 84 \times 100$ mm
Material: Aluminum

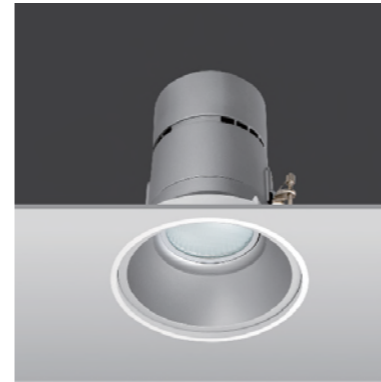
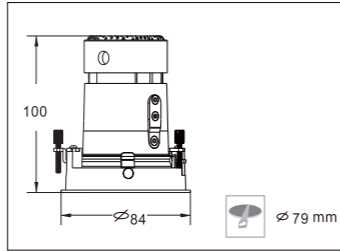

GJCAS-14W-F

LED Power: 14W
CCT: 2700K/3000K/4000K
CRI: 80 or 90
DC Voltage: 27.8V
DC Current: 500mA
Beam Angel: 20° 30° 55°
Dimension: $\Phi 118 \times 138$ mm
Material: Aluminum

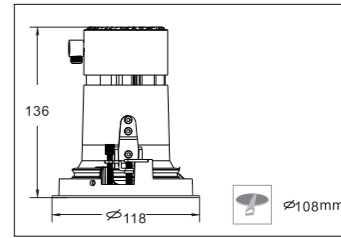

Medium

Beam Angle: 24°

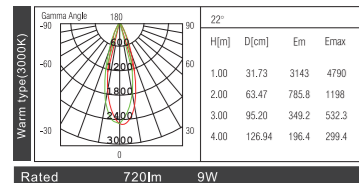

Wide

Beam Angle: 38°

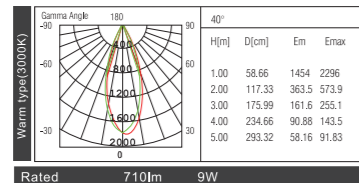

Narrow

Beam Angle: 20°

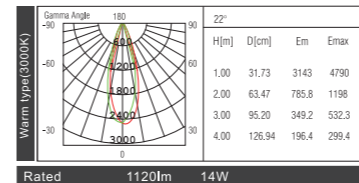

Medium

Beam Angle: 30°

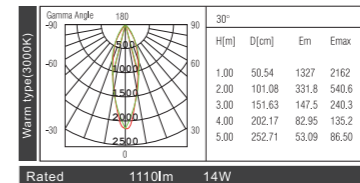



GJCAS-35W-F

LED Power: 35W
 CCT: 2700K/3000K/4000K
 CRI: 80 or 90
 DC Voltage: 33.7V
 DC Current: 700mA
 Beam Angel: 18° 30° 55°
 Dimension: $\Phi 153 \times 178$ mm
 Material: Aluminum

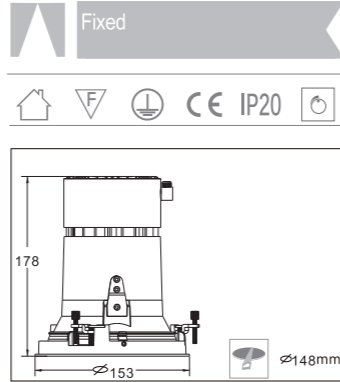

GJCAS-44W-F

LED Power: 44W
 CCT: 2700K/3000K/4000K
 CRI: 80 or 90
 DC Voltage: 30.4V
 DC Current: 1400mA
 Beam Angel: 24° 38° 55°
 Dimension: $\Phi 202 \times 245$ mm
 Material: Aluminum

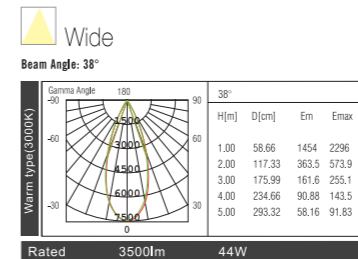
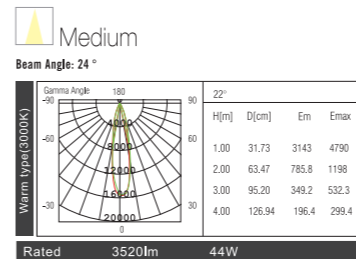
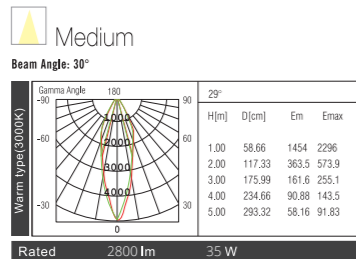
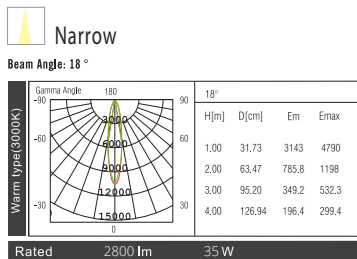
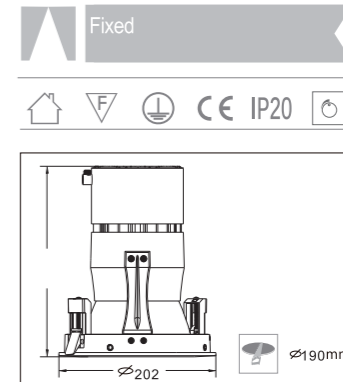



GJCAS-9W-A

LED Power: 9W
CCT: 2700K/3000K/4000K
CRI: 80 or 90
DC Voltage: 17.8V
DC Current: 500mA
Beam Angel: 24° 38° 55°
Dimension: $\Phi 84 \times 105$ mm
Material: Aluminum

Adjustable

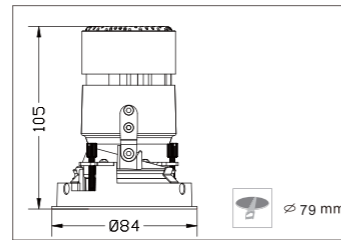

Medium

Beam Angle: 24°

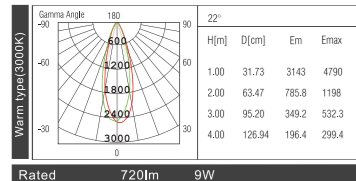

Medium

Beam Angle: 38°

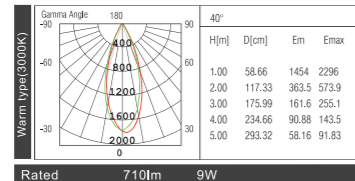

GJCAS-14W-A

LED Power: 14W
CCT: 2700K/3000K/4000K
CRI: 80 or 90
DC Voltage: 27.8V
DC Current: 500mA
Beam Angel: 24° 38° 55°
Dimension: $\Phi 118 \times 149$ mm
Material: Aluminum

Adjustable

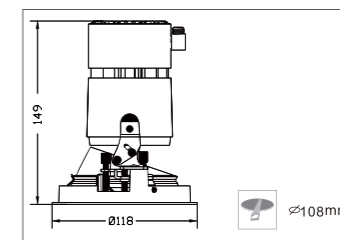

Narrow

Beam Angle: 24°

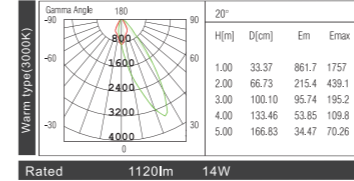

Medium

Beam Angle: 38°

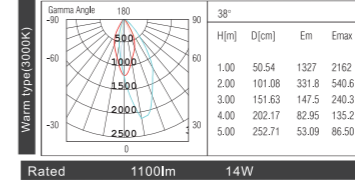

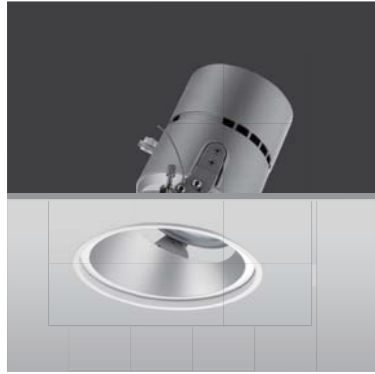

GJCAS-35W-A

LED Power: 35W
CCT: 2700K/3000K/4000K
CRI: 80 or 90
DC Voltage: 33.7V
DC Current: 700mA
Beam Angel: 24° 38° 55°
Dimension: $\Phi 153 \times 183$ mm
Material: Aluminum

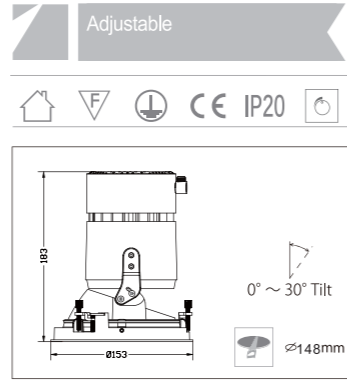

Narrow

Beam Angle: 20°

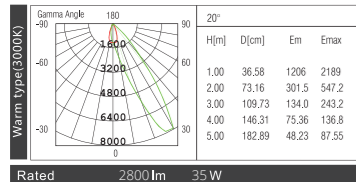

Medium

Beam Angle: 38°

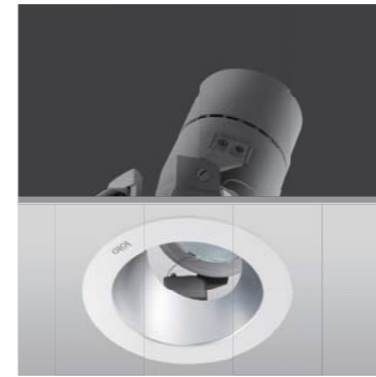
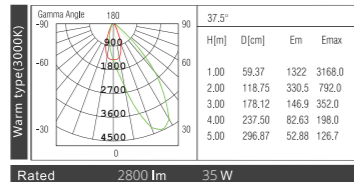

GJCAS-44W-A

LED Power: 44W
CCT: 2700K/3000K/4000K
CRI: 80 or 90
DC Voltage: 30.4V
DC Current: 1400mA
Beam Angel: 24° 38° 55°
Dimension: $\Phi 202 \times 245$ mm
Material: Aluminum

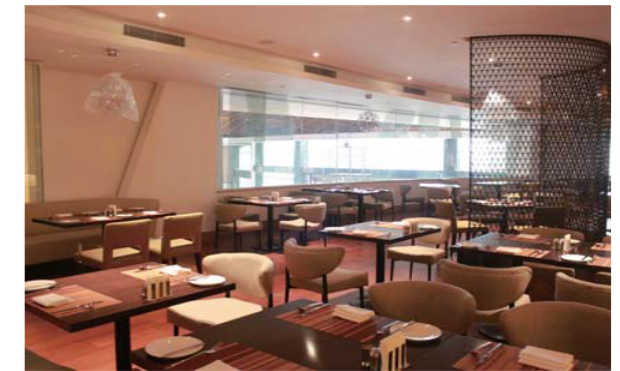
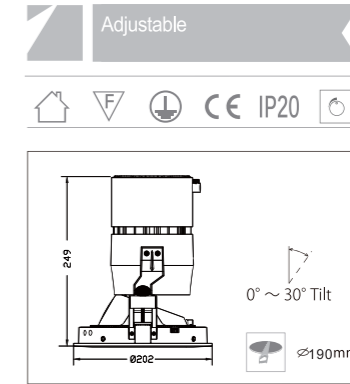

Narrow

Beam Angle: 20°

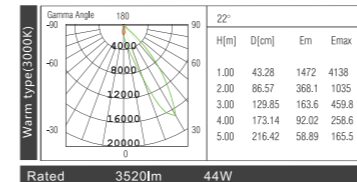

Medium

Beam Angle: 30°

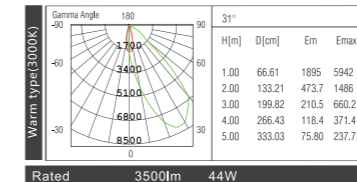

Castle Series IP66 LED Downlight



Φ125



Φ155



Castle Series IP66 can be installed(customized) in the ground to illuminate walkways for option, Standard edition is widely used in canopy for general lighting and accent lighting.



Sharp COB

SHARP



Double Reflector Control



Variety of Light Colour

2700K / 3000K / 3500K / 4000K / 5000K
CRI >80 or 90 for Option



2700K



3000K



3500K



4000K



5000K



GJCAS-25W-F-IP66

LED Power: 25W
CCT: 2700K/3000K/4000K
CRI: 80 or 90
DC Voltage: 35V
DC Current: 700mA
Beam Angel: 24°
Dimension: $\Phi 142 \times 152$ mm
Material: Aluminum

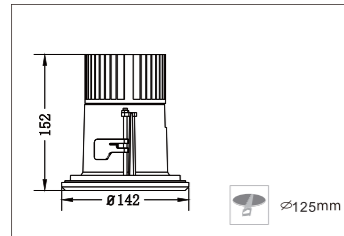

Narrow

Beam Angle: 24°

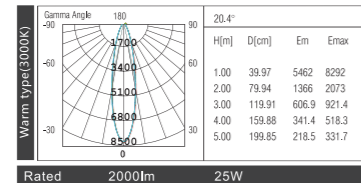

GJCAS-40W-F-IP66

LED Power: 40W
CCT: 2700K/3000K/4000K
CRI: 80 or 90
DC Voltage: 35V
DC Current: 1050mA
Beam Angel: 22° 36° 60°
Dimension: $\Phi 174 \times 174$ mm
Material: Aluminum

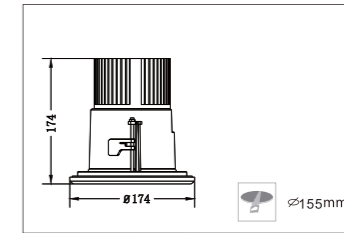

Narrow

Beam Angle: 22°

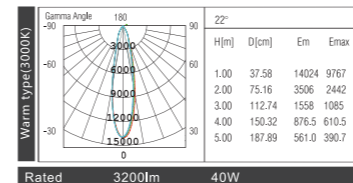

Medium

Beam Angle: 36°

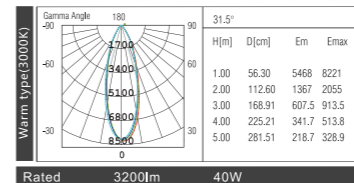

Wide

Beam Angle: 60°

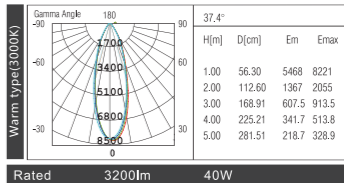



GJCAS-25W-A-IP66

LED Power: 25W
 CCT: 2700K/3000K/4000K
 CRI: 80 or 90
 DC Voltage: 35V
 DC Current: 700mA
 Beam Angle: 30° 60°
 Dimension: $\Phi 142 \times 152$ mm
 Material: Aluminum

Adjustable

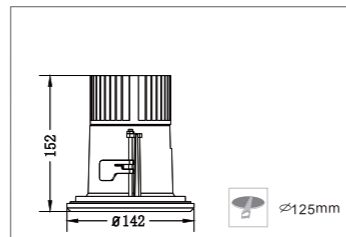

Narrow

Beam Angle: 24°

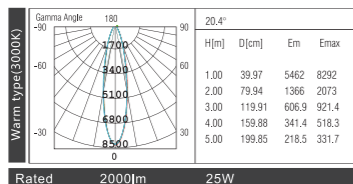

Rated 2000lm 25W



GJCAS-40W-A-IP66

LED Power: 40W
 CCT: 2700K/3000K/4000K
 CRI: 80 or 90
 DC Voltage: 35V
 DC Current: 1050mA
 Beam Angle: 30° 60°
 Dimension: $\Phi 174 \times 174$ mm
 Material: Aluminum

Adjustable

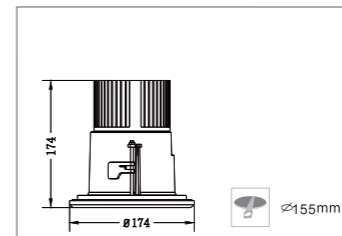

Narrow

Beam Angle: 30°

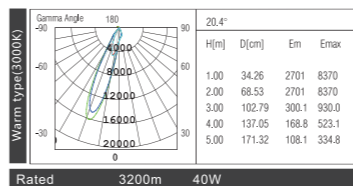

Rated 3200lm 40W



Wide

Beam Angle: 60°

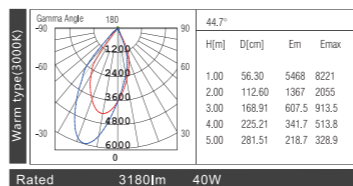

Rated 3180lm 40W