

Castle Series LED Downlight



Fix Angle



Φ79

Φ108

Φ148

Φ190



Adjustable Angle



Bridgelux COB

Low UGR <19, High Lumen Output



Double Reflector Control

Clear Lens and Diffused Lens Available
60° Cut-off Angle and Silver Finish



Variety of Light Colour

2700K / 3000K / 3500K / 4000K / 5000K
CRI >80 or 90 for Option

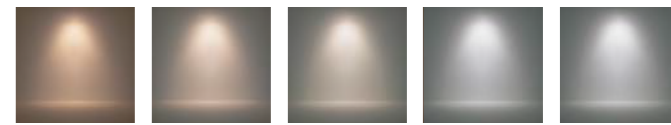

2700K

3000K

3500K

4000K

5000K

Easy Installation

Super Narrow Trim





GJCAS-9W-F

LED Power: 9W
CCT: 2700K/3000K/4000K
CRI: 80 or 90
DC Voltage: 17.8V
DC Current: 500mA
Beam Angel: 24° 38° 55°
Dimension: $\Phi 84 \times 100$ mm
Material: Aluminum

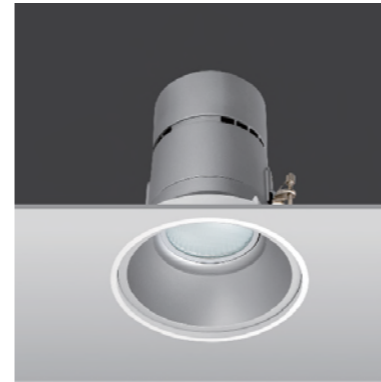
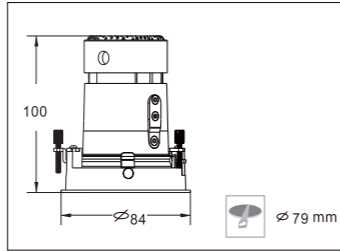

GJCAS-14W-F

LED Power: 14W
CCT: 2700K/3000K/4000K
CRI: 80 or 90
DC Voltage: 27.8V
DC Current: 500mA
Beam Angel: 20° 30° 55°
Dimension: $\Phi 118 \times 138$ mm
Material: Aluminum

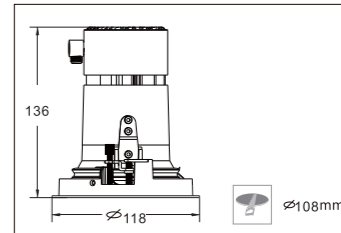

Medium

Beam Angle: 24°

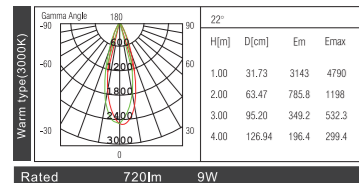

Wide

Beam Angle: 38°

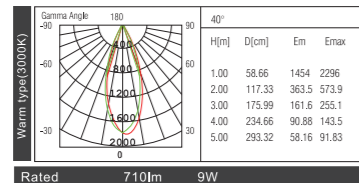

Narrow

Beam Angle: 20°

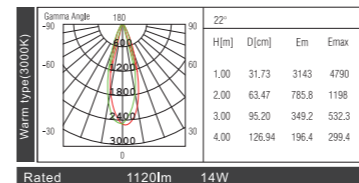

Medium

Beam Angle: 30°

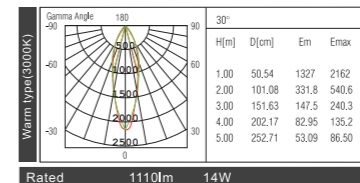



GJCAS-35W-F

LED Power: 35W
CCT: 2700K/3000K/4000K
CRI: 80 or 90
DC Voltage: 33.7V
DC Current: 700mA
Beam Angel: 18° 30° 55°
Dimension: $\Phi 153 \times 178$ mm
Material: Aluminum

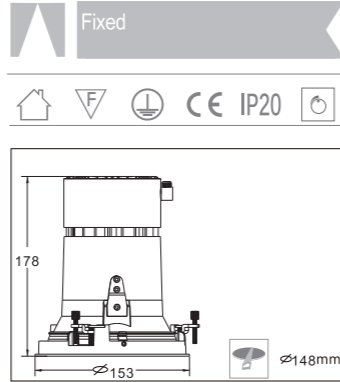

GJCAS-44W-F

LED Power: 44W
CCT: 2700K/3000K/4000K
CRI: 80 or 90
DC Voltage: 30.4V
DC Current: 1400mA
Beam Angel: 24° 38° 55°
Dimension: $\Phi 202 \times 245$ mm
Material: Aluminum

