

Mini Vega Series **Architectural** LED Downlight

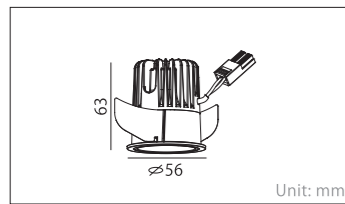

Base

LED Hotel Architectural Series

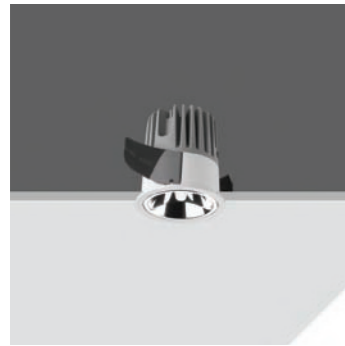

Lamp Source: CREE / CITIZEN / SHARP Color matching: 2700K / 3000K / 3500K / 4000K / 5000K / 6500K

Base	Cut-off angle 75°	Base	Cut-off angle 75°	Base	Cut-off angle 75°
COB LED(LUMINUS) 3W (Reflector beam angle: 15° / 25° / 38°)	COB LED(LUMINUS) 5W (Reflector beam angle: 15° / 25° / 38°)	COB LED(LUMINUS) 7W (Reflector beam angle: 15° / 25° / 38°)			
With DC 36V 100mA LED Driver	With DC 36V 150mA LED Driver	With DC 36V 200mA LED Driver			
AC 100V~240V 50/60Hz	AC 100V~240V 50/60Hz	AC 100V~240V 50/60Hz			
Ra 90	Ra 90	Ra 90			
Triac / 0-10V / Dali	Triac / 0-10V / Dali	Triac / 0-10V / Dali			
ø52mm	ø52mm	ø52mm			
GJMVE-3W-AF White	GJMVE-5W-AF White	GJMVE-7W-AF White			

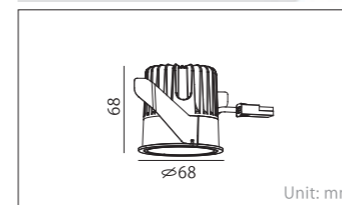
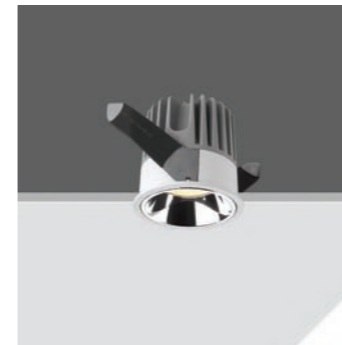

Base

LED Hotel Architectural Series



Lamp Source: CREE / CITIZEN / SHARP Color matching: 2700K / 3000K / 3500K / 4000K / 5000K / 6500K

Base	Cut-off angle 67°	Base	Cut-off angle 67°
COB LED(LUMINUS) 7W (Reflector beam angle: 15° / 25° / 38°)	COB LED(LUMINUS) 10W (Reflector beam angle: 15° / 25° / 38°)		
With DC 36V 200mA LED Driver	With DC 36V 250mA LED Driver		
AC 100V~240V 50/60Hz	AC 100V~240V 50/60Hz		
Ra 90	Ra 90		
Triac / 0-10V / Dali	Triac / 0-10V / Dali		
ø64mm	ø64mm		
GJMVE-7W-BF White	GJMVE-10W-BF White		

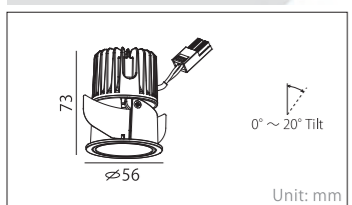

Adjustable

LED Hotel Architectural Series



Lamp Source: CREE / CITIZEN / SHARP Color matching: 2700K / 3000K / 3500K / 4000K / 5000K / 6500K

Adjustable	Cut-off angle 75°	Adjustable	Cut-off angle 75°	Adjustable	Cut-off angle 75°
COB LED(LUMINUS) 3W (Reflector beam angle: 15° / 25° / 38°)	COB LED(LUMINUS) 5W (Reflector beam angle: 15° / 25° / 38°)	COB LED(LUMINUS) 7W (Reflector beam angle: 15° / 25° / 38°)			
With DC 36V 100mA LED Driver	With DC 36V 150mA LED Driver	With DC 36V 200mA LED Driver			
AC 100V~240V 50/60Hz	AC 100V~240V 50/60Hz	AC 100V~240V 50/60Hz			
Ra 90	Ra 90	Ra 90			
Triac / 0-10V / Dali	Triac / 0-10V / Dali	Triac / 0-10V / Dali			
ø52mm	ø52mm	ø52mm			
GJMVE-3W-AG White	GJMVE-5W-AG White	GJMVE-7W-AG White			

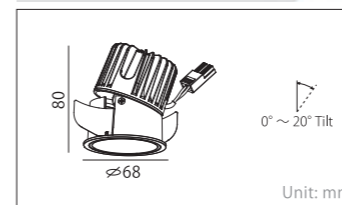
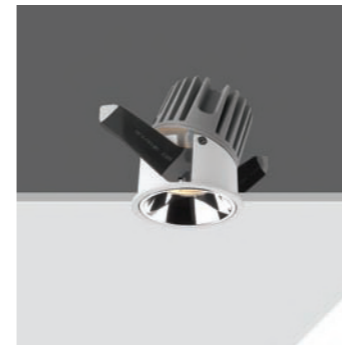

Adjustable

LED Hotel Architectural Series



Lamp Source: CREE / CITIZEN / SHARP Color matching: 2700K / 3000K / 3500K / 4000K / 5000K / 6500K

Adjustable	Cut-off angle 67°	Adjustable	Cut-off angle 67°
COB LED(LUMINUS) 7W (Reflector beam angle: 15° / 25° / 38°)	COB LED(LUMINUS) 10W (Reflector beam angle: 15° / 25° / 38°)		
With DC 36V 200mA LED Driver	With DC 36V 250mA LED Driver		
AC 100V~240V 50/60Hz	AC 100V~240V 50/60Hz		
Ra 90	Ra 90		
Triac / 0-10V / Dali	Triac / 0-10V / Dali		
ø64mm	ø64mm		
GJMVE-7W-BG White	GJMVE-10W-BG White		

Mini Vega Series **Architectural** LED Downlight

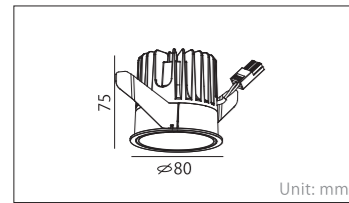

Base

LED Hotel architectural Series

Lamp Source: CREE / CITIZEN / SHARP Color matching: 2700K / 3000K / 3500K / 4000K / 5000K / 6500K

Base	Cut-off angle 57°	Base	Cut-off angle 57°	Base	Cut-off angle 57°
COB LED(LUMINUS) 7W (Reflector beam angle: 15° / 25° / 38°)		COB LED(LUMINUS) 10W (Reflector beam angle: 15° / 25° / 38°)		COB LED(LUMINUS) 15W (Reflector beam angle: 15° / 25° / 38°)	
With DC 36V 200mA LED Driver		With DC 36V 250mA LED Driver		With DC 36V 400mA LED Driver	
AC 100V~240V 50/60Hz		AC 100V~240V 50/60Hz		AC 100V~240V 50/60Hz	
Ra 90		Ra 90		Ra 90	
Triac / 0-10V / Dali		Triac / 0-10V / Dali		Triac / 0-10V / Dali	
\varnothing 75mm		\varnothing 75mm		\varnothing 75mm	
GJMVE-7W-CF White		GJMVE-10W-CF White		GJMVE-15W-CF White	

IP20

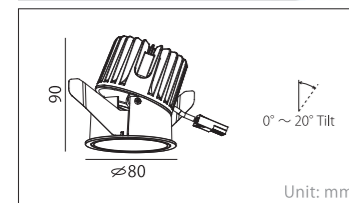

Adjustable

LED Hotel architectural Series

Lamp Source: CREE / CITIZEN / SHARP Color matching: 2700K / 3000K / 3500K / 4000K / 5000K / 6500K

Adjustable	Cut-off angle 57°	Adjustable	Cut-off angle 57°	Adjustable	Cut-off angle 57°
COB LED(LUMINUS) 7W (Reflector beam angle: 15° / 25° / 38°)		COB LED(LUMINUS) 10W (Reflector beam angle: 15° / 25° / 38°)		COB LED(LUMINUS) 15W (Reflector beam angle: 15° / 25° / 38°)	
With DC 36V 200mA LED Driver		With DC 36V 250mA LED Driver		With DC 36V 400mA LED Driver	
AC 100V~240V 50/60Hz		AC 100V~240V 50/60Hz		AC 100V~240V 50/60Hz	
Ra 90		Ra 90		Ra 90	
Triac / 0-10V / Dali		Triac / 0-10V / Dali		Triac / 0-10V / Dali	
\varnothing 75mm		\varnothing 75mm		\varnothing 75mm	
GJMVE-7W-CF White		GJMVE-10W-CF White		GJMVE-15W-CF White	

IP20



Model#	Dimensions (mm)	Cutout (mm)	Beam Angle	Power (W)	Housing Colour	LED	Dimmer (options)
GJMVE-Fixed	Ø56*63	Ø52		3W/5W/7W			
	Ø68*68	Ø64		7W/10W			
	Ø80*75	Ø75	15° 25° 38°	7W/10W/15W	White Silver Black	COB	Triac 0-10V Dali
GJMVE-Gimbal	Ø56*73	Ø52		3W/5W/7W			
	Ø68*80	Ø64		7W/10W			
	Ø80*90	Ø75		7W/10W/15W			

- IES
- LM80
- RCM
- SAA
- IP20
- TUV
- CE
- 5 Yrs
Warranty