

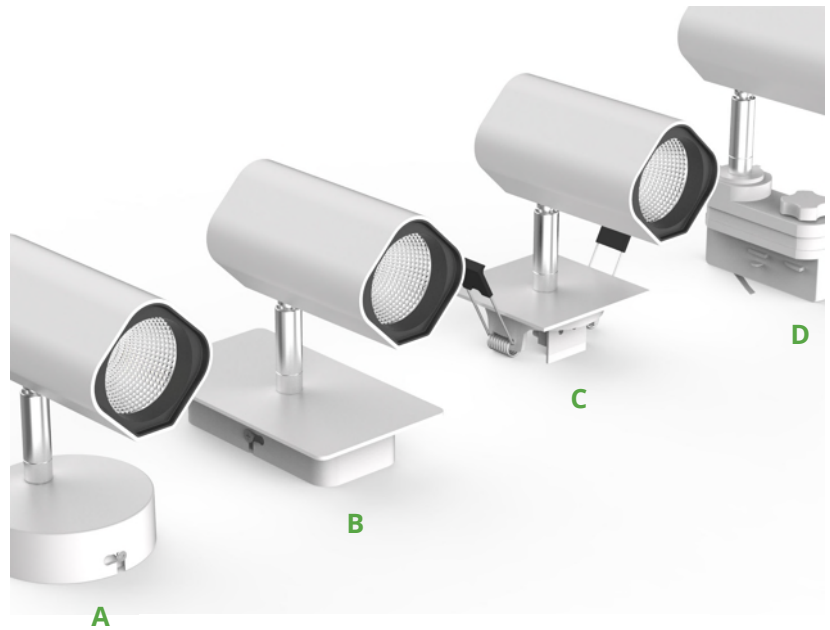

greenlux
cost reduction LED lighting

Accord Series 01 LED Track Spot Light



- Available in multiple installation: recessed, surface mounted & track mounted
- 340° horizontal & 90° vertical rotatable
- High quality COB light source
- Performs high efficiency and energy saving, Up to 80% energy saving compared to standard CFL
- Replaces traditional track lights
- IP20 for indoor use only
- 3 Years Warranty
- Applications include shopping centres, galleries, cafes, hotels, theatres, museums & display cases

Specifications

Colour Range	2700 ~ 5000K
Lumens	80 ~ 85lm/W
Power Consumption	10W / 20W / 30W / 40W
Input Voltage	100V/240V AC
Chipset	COB
Beam angle	24° / 36° / 45° / 60°
Power Factor	>0.9
Dimmable	Triac Dimmer (option)
CRI	>80
IP	20



Materials

Housing Materials	Aluminum Die-casting
Housing Colour	White or Black

DEEP CYLINDER DESIGN

for light outlet makes the light softer and cozier

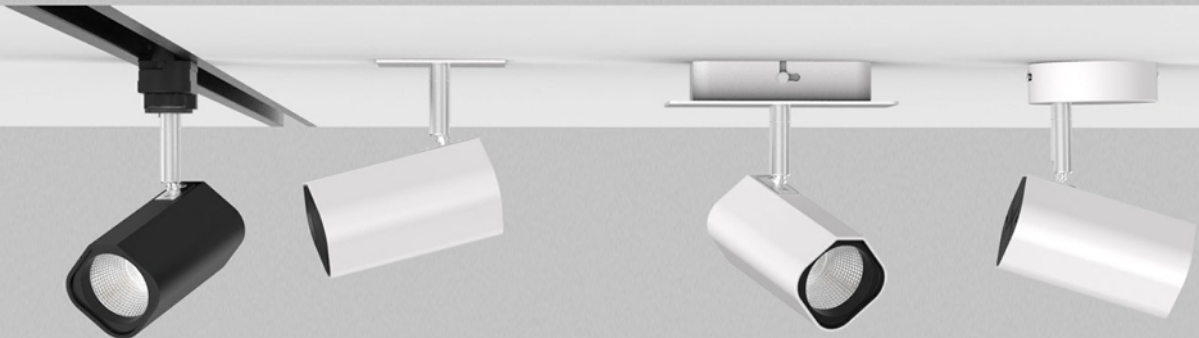

Track

Recessed

Surface Mounted

MODULARIZATION DESIGN

facilitates replacing universal head connection elements, which realizes diversified installation ways in one lamp

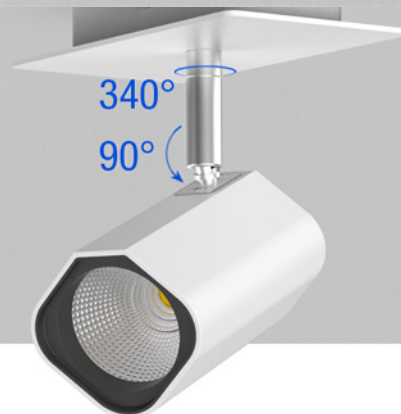

ADJUSTABLE LIGHTING

orientation with 340 degree in horizontal direction and 90 in vertical direction provided



Accord Series 01 LED Track Spot Light



BEAM ANGLE

15°

24°

36°

60°





greenlux
cost reduction LED lighting

Accord Series 01 LED Track Spot Light

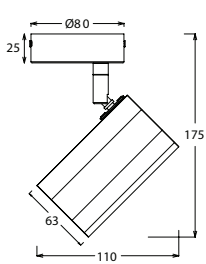

A

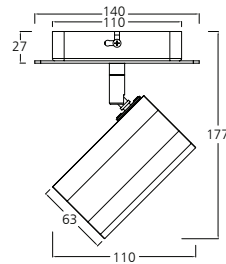

B

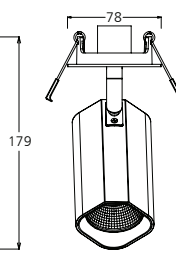
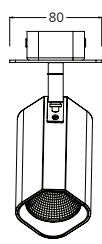

C

10W

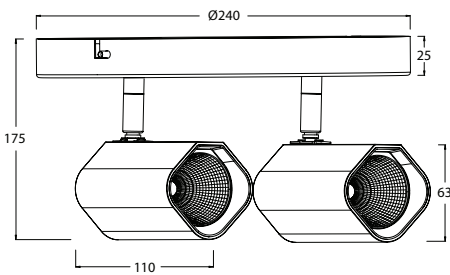

A-Double

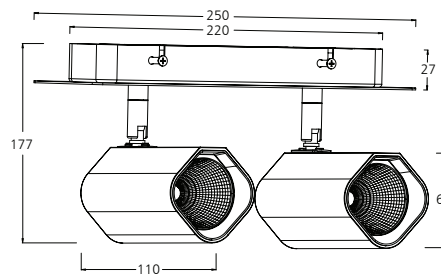

B-Double

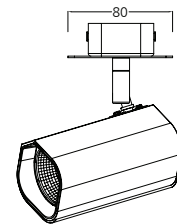

20W

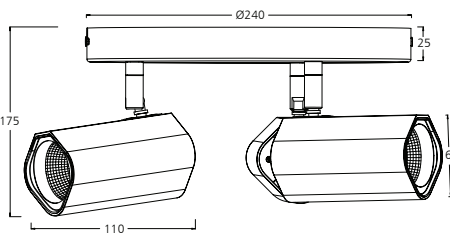

A-Triple

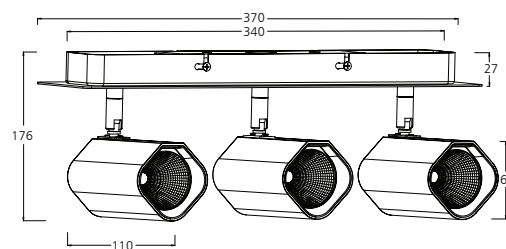

B-Triple

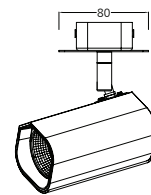

30W

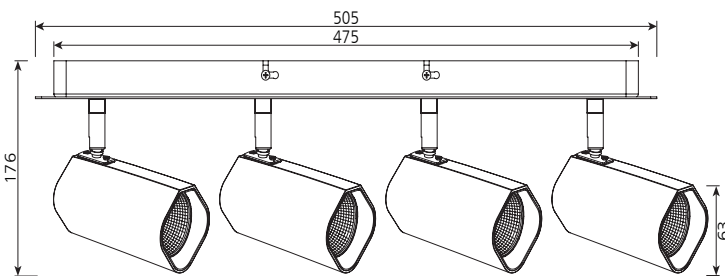

B-Quad

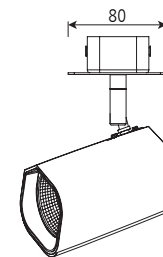

40W



greenlux
cost reduction LED lighting

Accord Series 01 LED Track Spot Light

Model	Installation	Product size (mm)	LED	Beam Angle	Dimmable (option)
GUACC-10W-01-A	Surface Mounted-A	110x63x175	COB	24°/36°/45°/60°	Triac
GUACC-20W-01-A	Surface Mounted-A	240x63x175	COB	24°/36°/45°/60°	Triac
GUACC-30W-01-A	Surface Mounted-A	240x63x175	COB	24°/36°/45°/60°	Triac
GUACC-10W-01-B	Surface Mounted-B	110x63x177	COB	24°/36°/45°/60°	Triac
GUACC-20W-01-B	Surface Mounted-B	250x63x177	COB	24°/36°/45°/60°	Triac
GUACC-30W-01-B	Surface Mounted-B	370x63x177	COB	24°/36°/45°/60°	Triac
GUACC-40W-01-B	Surface Mounted-B	505x63x177	COB	24°/36°/45°/60°	Triac
GUACC-10W-01-C	Recessed-C	110x63x179	COB	24°/36°/45°/60°	Triac
GUACC-10W-01-D	Track Mounted-D	110x63x179	COB	24°/36°/45°/60°	Triac

