



**greenlux**  
cost reduction LED lighting

# Venus 03 Series LED Street/Garden Light

Available in Multiple Wattage  
80% lumen maintenance at 50,000 hours

- Class II electric insulation
- Double photomnum diffuser technology
- Supper white toughened glass
- Sealed lamp housing
- High quality die-casting aluminium housing with aluminium sheet rotating cover
- High lumen output 90lm/W
- High efficiency Cree LED chipset
- Photocell sensor available
- IP65 Rated for external use
- Applications include streets, gardens, parks, and commercial sites

## Specifications

<b>Colour Range</b>	3000 ~ 6500k
<b>Power Consumption</b>	35W / 50W / 60W
<b>Product Dimensions (mm)</b>	Ø650*674 (L*W*H)
<b>Lumen</b>	3200lm ~ 5870lm
<b>Input Voltage</b>	AC 100-240V
<b>Beam angle</b>	160°
<b>CRI</b>	>75
<b>Power Factor</b>	>0.95
<b>Weight</b>	11.5kg
<b>Pipe Diameter</b>	76mm
<b>Driver</b>	Mean Well
<b>Housing Color</b>	Black / Grey





**greenlux**  
cost reduction LED lighting

# Venus 03 Series LED Street/Garden Light

## Pole Data

<b>Pole</b>	Carbon Steel
<b>Material</b>	Hot Galvanizing Surface Treatment with Powder Coating
<b>Thickness (mm)</b>	2.5 / 3
<b>Bottom Flange Thickness</b>	10mm
<b>Assembly Size</b>	Ø76mm
<b>Pole Height (m)</b>	2.6 / 2.75 / 4

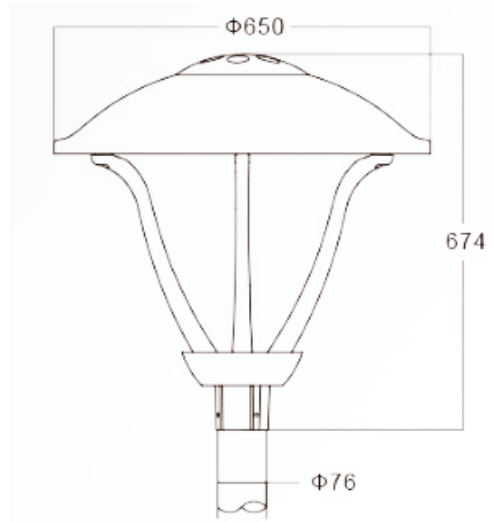

## Photometrics

**Type 1**

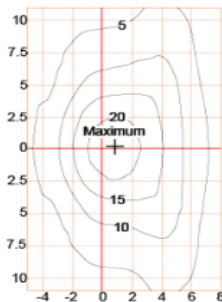
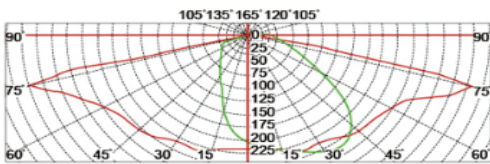

**Type 2**

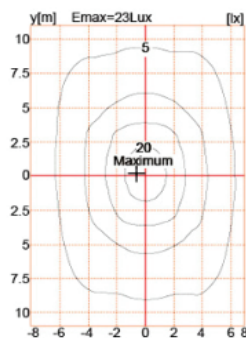
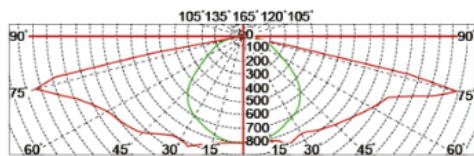

**Type 3**

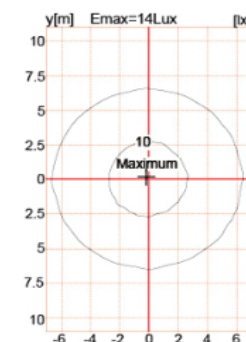
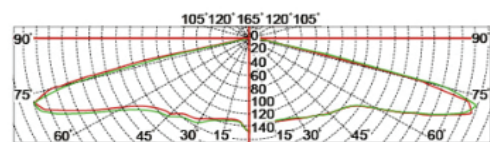



**greenlux**  
cost reduction LED lighting

# Venus 03 Series LED Street/Garden Light

## Pole Size Diagrams

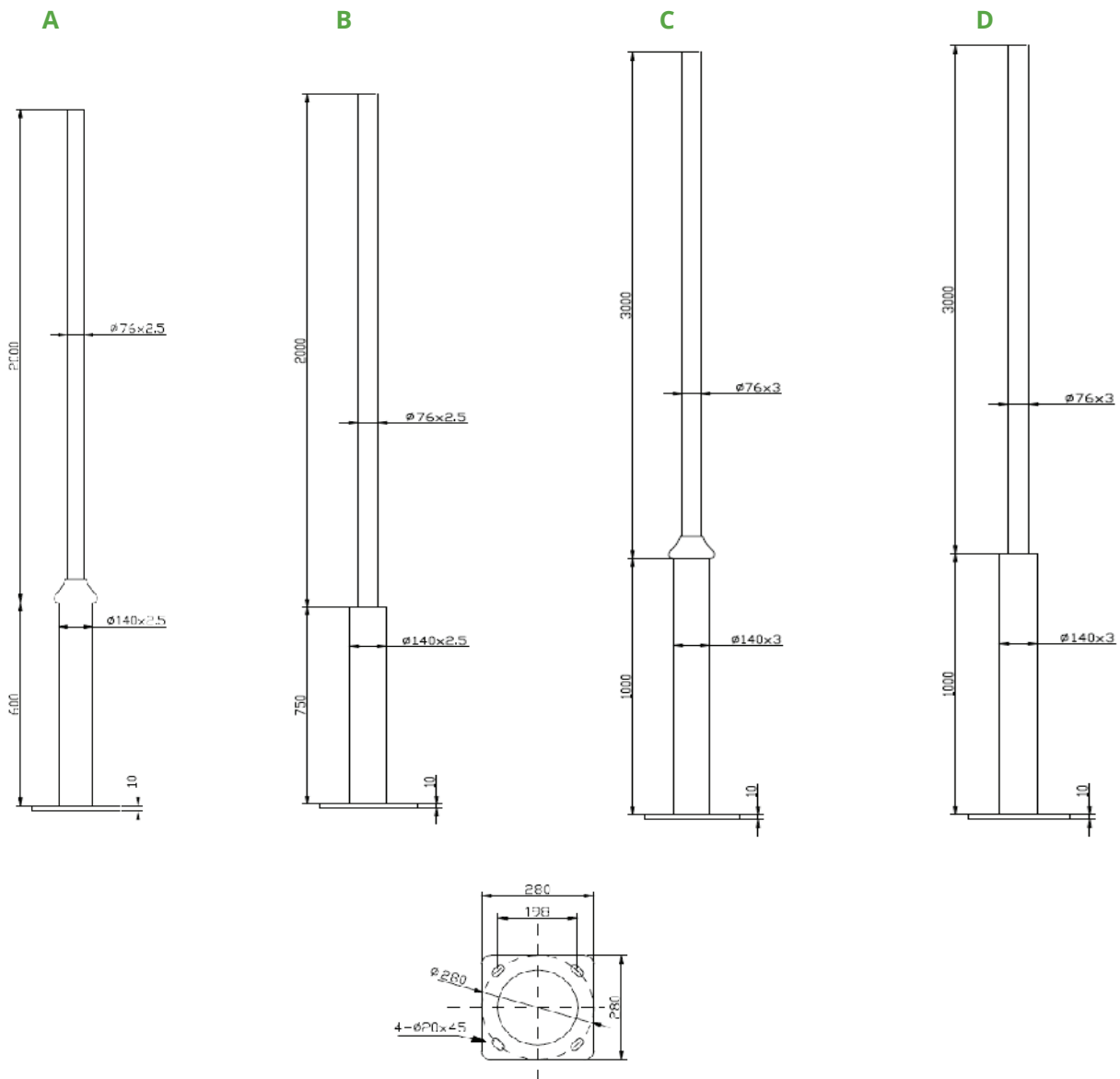

MODEL	Beam Angle (°)	Wattage (W)	Voltage (V)	LED	CCT (k)	Lumen	Pipe Diameter (mm)	Size (mm) (LxWxD)	Surface Colour
GYVEN-35W-03	160	35W	100/240	Cree	3000-6500	3430	76	Ø650*674	Black Grey
GYVEN-50W-03		50W				4900		Ø650*674	
GYVEN-60W-03		60W				5870		Ø650*674	