



greenlux
cost reduction LED lighting

Venus 04 Series LED Street/Garden Light

Available in Multiple Wattage
80% lumen maintenance at 50,000 hours

- Class II electric insulation
- Double photomnum diffuser technology
- Supper white toughened glass
- Sealed lamp housing
- High quality die-casting aluminium housing with aluminium sheet rotating cover
- High lumen output 90lm/W
- High efficiency Cree LED chipset
- Photocell sensor available
- IP65 Rated for external use
- Applications include streets, gardens, parks, and commercial sites

Specifications

Colour Range	3000 ~ 6500k
Power Consumption	30W / 45W / 55W
Product Dimensions (mm)	Ø666*764 (L*W*H)
Lumen	2750lm ~ 5390lm
Input Voltage	AC 100-240V
Beam angle	160°
CRI	>75
Power Factor	>0.95
Weight	14.2kg
Pipe Diameter	76mm
Driver	Mean Well
Housing Color	Black / Grey





greenlux
cost reduction LED lighting

Venus 04 Series LED Street/Garden Light

Pole Data

Pole	Carbon Steel
Material	Hot Galvanizing Surface Treatment with Powder Coating
Thickness (mm)	2.5 / 3
Bottom Flange Thickness	10mm
Assembly Size	Ø76mm
Pole Height (m)	2.6 / 2.75 / 4

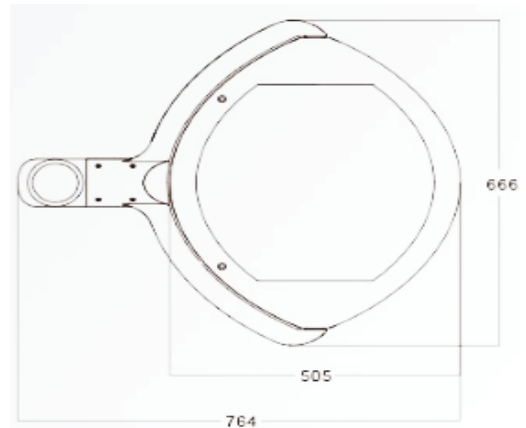

Photometrics

Type 1

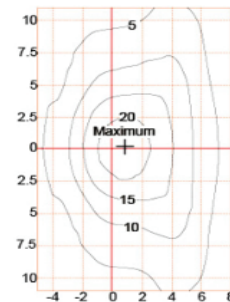
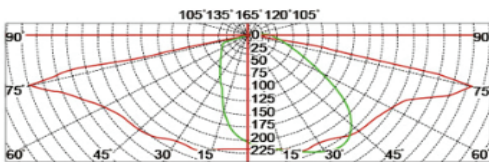

Type 2

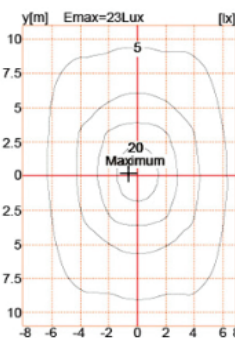
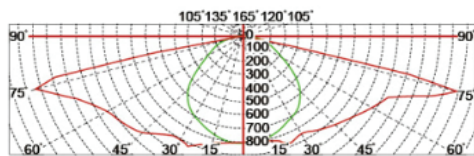

Type 3

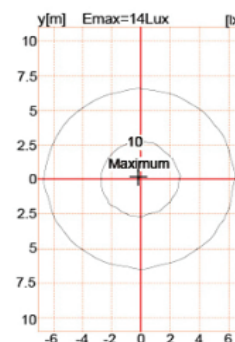
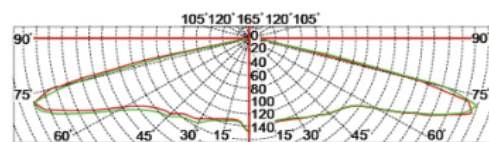



greenlux
cost reduction LED lighting

Venus 04 Series LED Street/Garden Light

Pole Size Diagrams

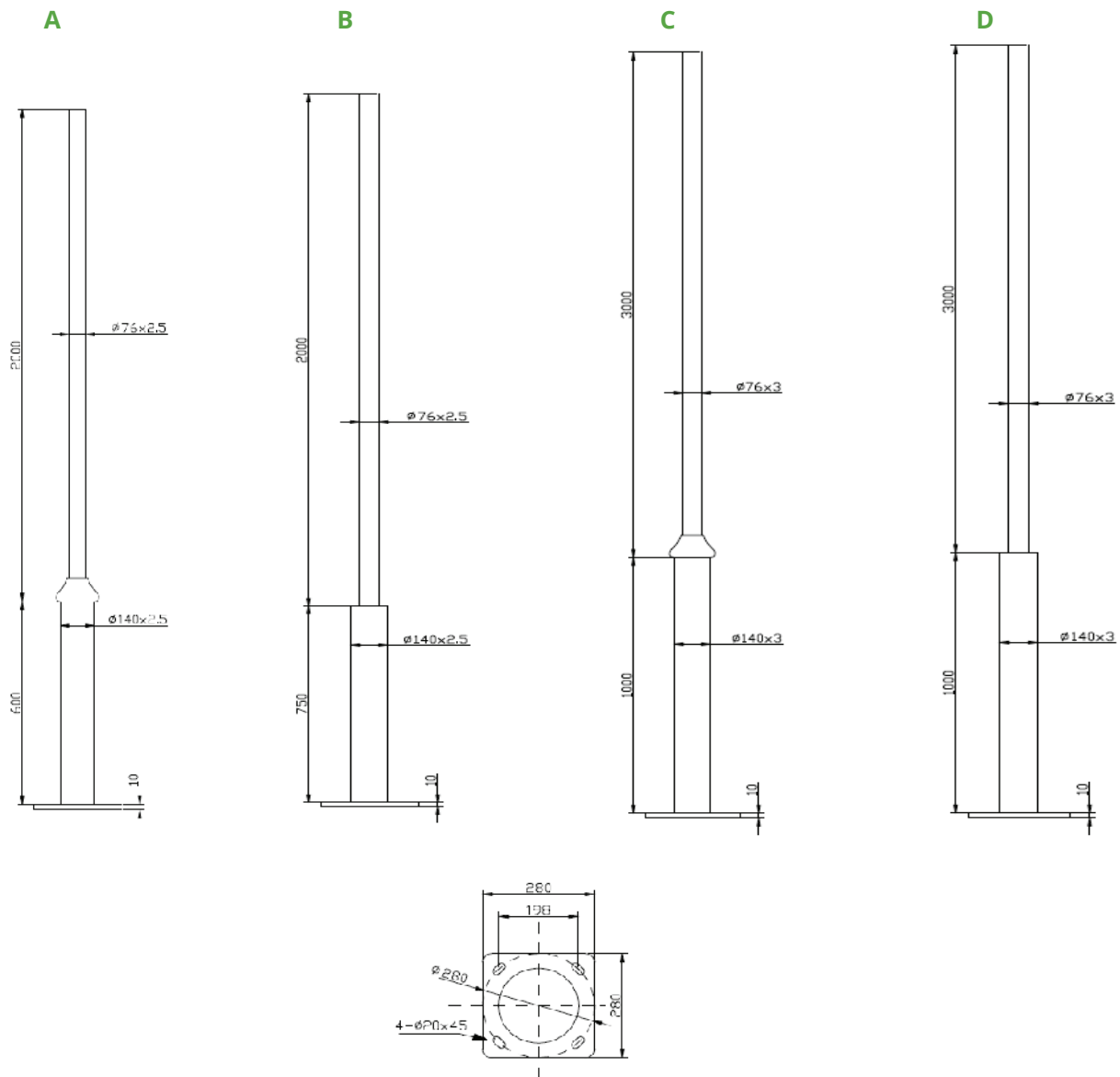

MODEL	Beam Angle (°)	Wattage (W)	Voltage (V)	LED	CCT (k)	Lumen	Pipe Diameter (mm)	Size (mm) (LxWxD)	Surface Colour
GYVEN-30W-04	160	30W	100/240	Cree	3000-6500	2940	76	Ø666*764	Black Grey
GYVEN-45W-04		45W				4400		Ø666*764	
GYVEN-55W-04		55W				5390		Ø666*764	