

Chain GLH 5490 Series **Up/Down** LED Linear Light

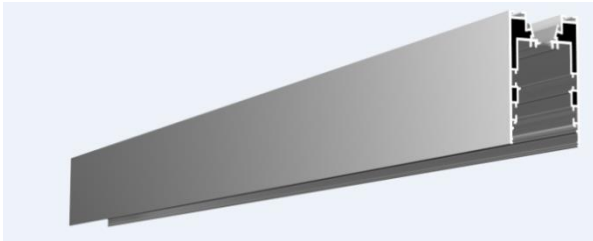

- Professional optical design with four diffusers and multiple specially designed light source
- Plug and connect design with innovative magnetic end cap
- No need to punch holes by pressing the carrier with snap joint easily
- Cord master design & built-in driver for extreme extension
- Three optional colours of black, white and silver

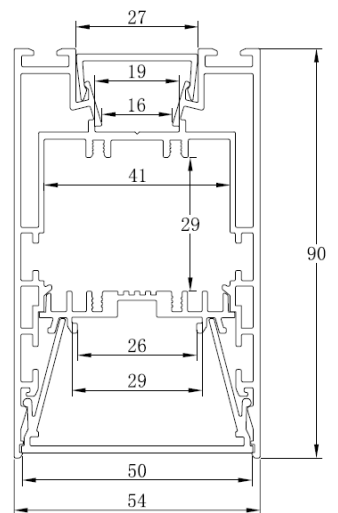

Chain GLH 5490 Series Up/Down LED Linear Light

Details

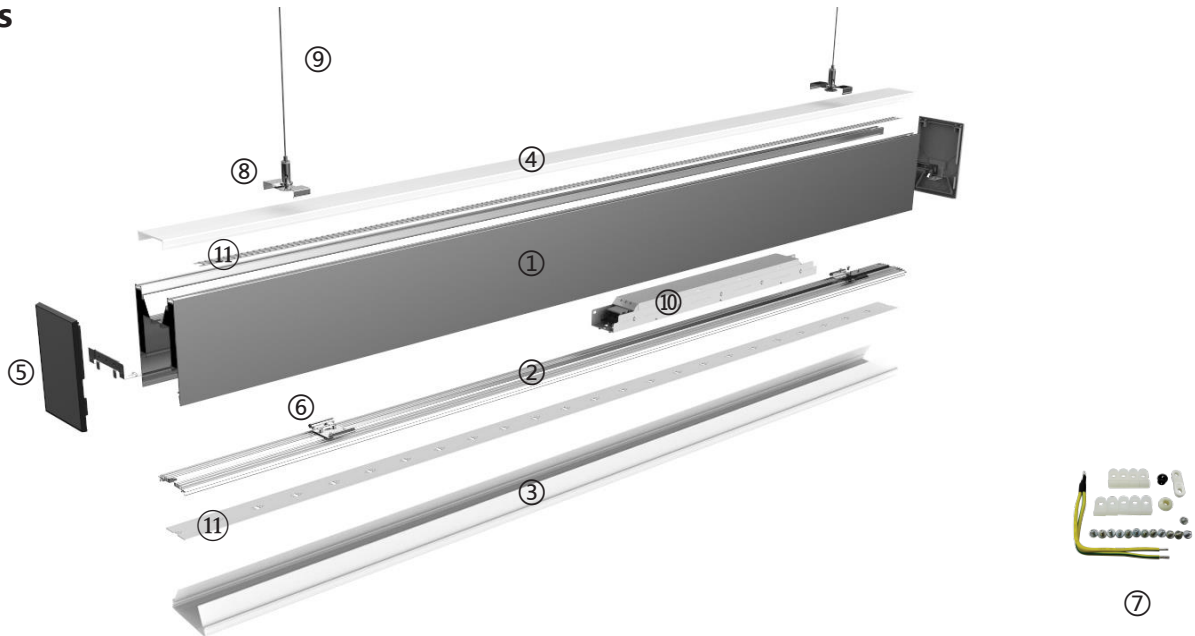

Standard Configuration

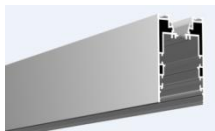

① Profile:

Installation: pendant/surface-mount
 Material : AL6063-T5
 Applications: Indoors
 Profile Weight : 5.16kg/2.5m
 Size : L2500*W54*H90mm
 Surface Processing: Anodizing/ Powder Coating

② Carrier

Material : AL6063-T5
 Surface technics : anodic oxidation



Flat



Asymmetric



Frosted diffuser



UGR filter diffuser

③ Diffuser

Material: PC/PC&PET
 Light Transmittance : 80%/65%
 Size : L2500*W50.8*H29.4mm
 PC Feature :The diffuser will extend (shrink)
 0.8mm/m when the temperature rises

③ Grating

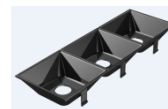

Material :Fireproof PC
 Size : L150*W50*H25mm



③ regressed



AL6063-T5 anodic oxidation L2500*W50*H6mm







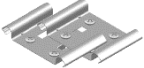



④ Diffuser

L2500*W26.6*H10.2mm Frosted PC Light transmittance85%

Chain GLH 5490 Series **Up/Down** LED Linear Light

	⑤ End	L56.9*W91.5*H9mm	Aluminum & fireproof PC& magnet
	⑥ Snap joint	L39.8*W42*H8.8mm	304 Stainless steel
	⑦ Accessories		
	⑧ Clip	L37*W20*H7mm	304 Stainless steel

Optional Accessories

	⑨ Pendant cable with	Steel cable D1.5*2000/4000mm	Junction box L80*W80*H30mm
	⑨ Pendant cable without	Steel cable D1.5*2000/4000mm	
	⑩ Driver	GCBDD-V24-065S/BSD-V24-065S/BD-V24-060P	
	⑪ FPC	GCD8320-24V-25mm	23W/m width 25mm Min. cutting unit 50mm
	⑪ Rigid modular	GCDY8320-24V-28mm	23W/m width 28mm Min. cutting unit 50mm
	⑪ FPC *	GCD8160-24V-14mm	12W/m width 14mm Min. cutting unit 50mm
	⑪ Rigid modular *	GCDY8160-24V-18mm	12W/m width 16mm Min. cutting unit 50mm
	⑪ Grating light source module	GCM10624V035028XX DC24V 8W/ PCS Width 28mm Length 300mm Angle 10°/24°/36°/48°/35*10°	
	Cord master	GCSPCC&PC	

* For up lighting

Chain GLH 5490 Series Up/Down LED Linear Light

Optical

◆Frosted diffuser(1.2m luminaire)

AAI Figure

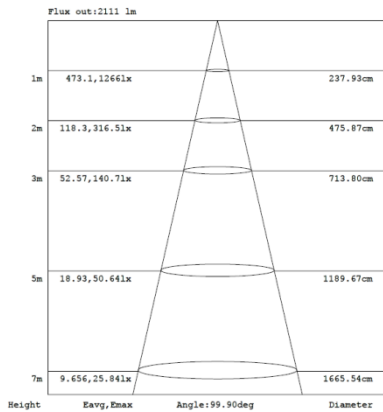

Luminous intensity distribution diagram

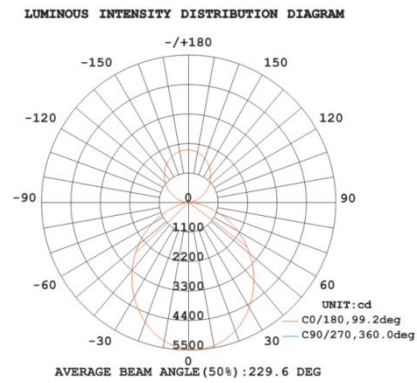

◆UGR filter diffuser(1.2m luminaire)

AAI Figure

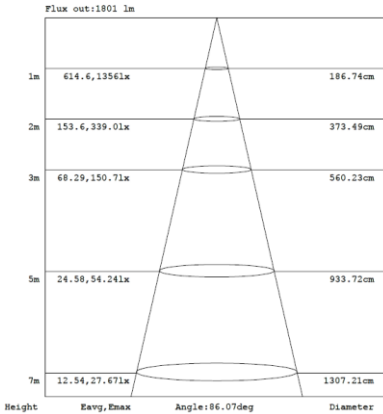

Luminous intensity distribution diagram

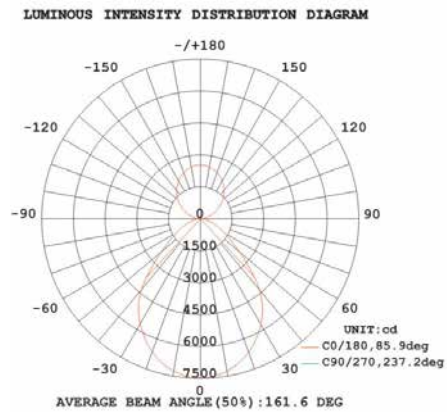

◆Matching with grating and 48° grating light source module (1.2m luminaire)

AAI Figure

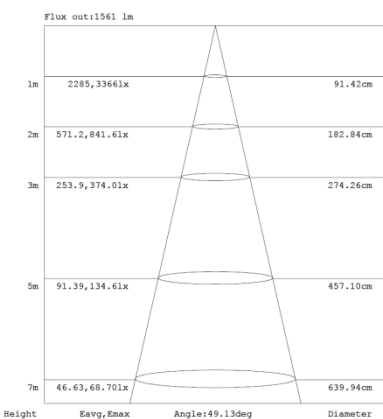



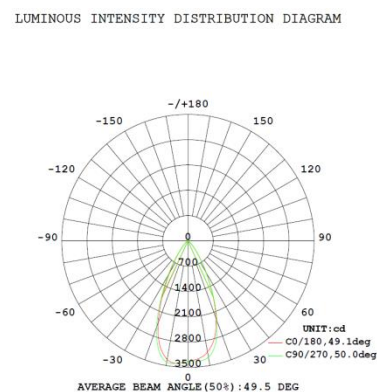





















Luminous intensity distribution diagram



Chain GLH 5490 Series **Up/Down** LED Linear Light

Options of Diffuser

Standard product + flexible

Profile (semi-assembled components)							
Opal Diffuser GLH5490DD	Item	Profile	Carrier	Frosted diffuser	diffuser	End cap	Snap joint
	PIC						
	Amount	1 pcs	1 pcs	1 pcs	1 pcs	End cap *2 pcs End cap kit *2 pcs	4 pcs
Options	Customisable length: ≤2.5m						
UGR Diffuser GLH5490DP	Item	Profile	Carrier	UGR filter diffuser	diffuser	End cap	Snap joint
	PIC						
	Amount	1 pcs	1 pcs	1 pcs	1 pcs	End cap *2 pcs End cap kit *2 pcs	4 pcs
Options	Customisable length: ≤2.5m						
Grating Diffuser GLH5490G	Item	Profile	Carrier	Grating	diffuser	End cap	Snap joint
	PIC						
	Amount	1 pcs	1 pcs	1 pcs	1 pcs	End cap *2 pcs End cap kit *2 pcs	4 pcs
Options	Customisable length: ≤2.4m						
Frosted Diffuser GLH5490FDG	Item	Profile	Carrier	Frosted diffuser	diffuser	End cap	Snap joint
	PIC						
	Amount	1 pcs	1 pcs	1 pcs	1 pcs	End cap *2 pcs End cap kit *2 pcs	4 pcs
Options	Customisable length: ≤2.5m						