

# Chain GLH 73108 Series Up/Down LED Linear Light

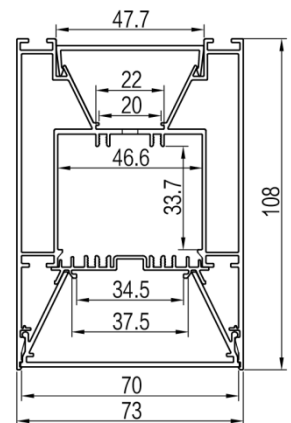

## Features

- Professional optical design with two diffusers and four types of light sources
- Plug and connect design with innovative magnetic end cap
- No need to punch holes by pressing the carrier with snap joint easily
- Connect more easily by tightening and screwing from the front
- Create any lighting sculpture freely by the five kinds of corners
- Cord master design & built-in driver for extreme extension
- Three optional colours of black, white and silver



# Chain GLH 73108 Series Up/Down LED Linear Light

## Details

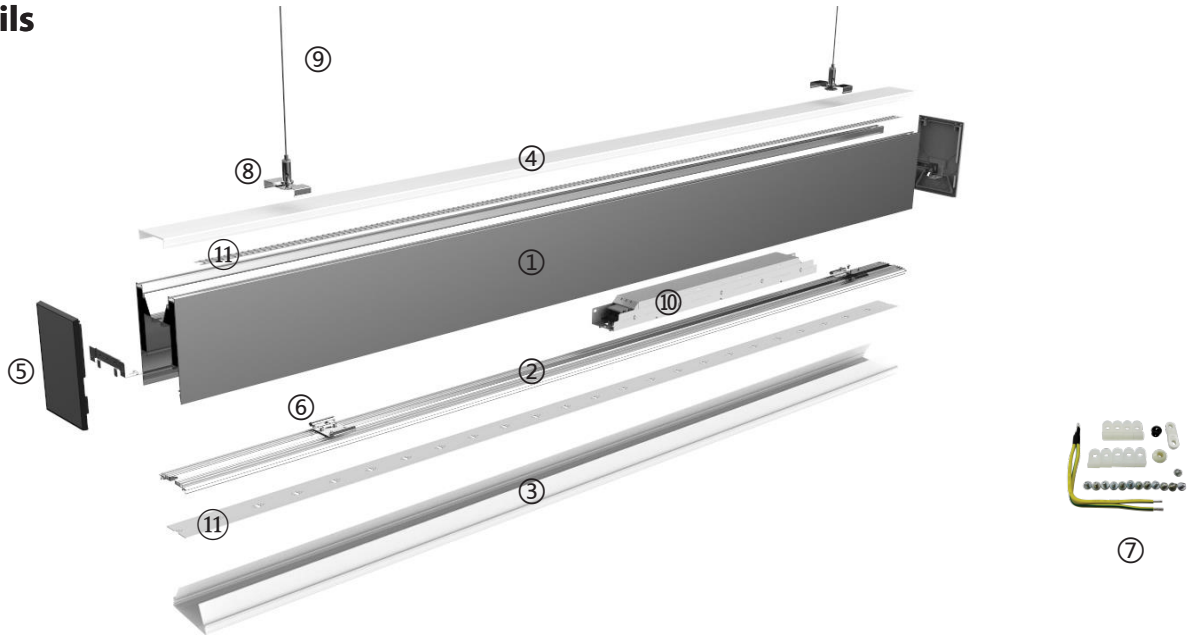



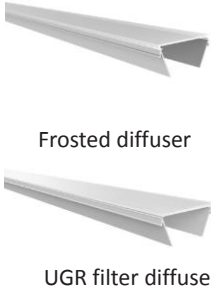





## Standard Configuration

	<p><b>① Profile ② Carrier:</b>          Installation: Pendant          Material: AL6063-T5          Applications: Indoors          Profile Weight: 5.49kg/2.5m          Size: L2500*W73*H108mm          Surface Processing: Anodizing/ Powder Coating</p>	 <p><b>③ Diffuser:</b>          Material: PC/PC&amp;PET          Light Transmittance : 80%/65%          Size : L2500*W70.6*H31mm          PC Feature : The diffuser will extend (shrink) 0.8mm/m when the temperature rises (drops) 10°C.</p>
--	---	---

	<b>④ Diffuser</b>	L2500*W48*H10mm	Frosted PC Light transmittance85%
	<b>⑤ End cap</b>	L75.6*W109.4*H9mm	Aluminum & fireproof PC&magnet
	<b>⑥ Snap joint</b>	L46.5*W30*H6.5mm	304 Stainless steel
	<b>⑦ Accessories</b>		
	<b>⑧ Clip</b>	L54.7*W20*H8.7mm	304 Stainless steel

# Chain GLH 73108 Series Up/Down LED Linear Light

## Optional Accessories

	⑧ Clip	GCL54.7*W20*H8.7mm	304 Stainless steel
	⑨ Pendant cable with junction box		Steel cable D1.5*2000/4000mm Junction box L80*W80*H30mm
	⑨ Pendant cable without junction box		Steel cable D1.5*2000/4000mm
	⑩ Driver	GCBDD-V24-065S/BSD-V24-065S/BD-V24-060P	
	⑪ FPC	GCD8320-24V-34mm	20W/m width 34mm Min. cutting unit 50mm
	⑪ Rigid modular	GCDY8320-24V-37mm	20W/m width 37mm Min. cutting unit 50mm
	⑪ FPC*	GCD8280-24V-15mm	20W/m width 15mm Min. cutting unit 50mm
	Aluminum diffuser	GCA6063-T5	Anodizing L2500*W50*H6mm
	Cord master	GCSPCC & PC	

\* For up lighting

## Corners

L-type corner (L90-LH73108)

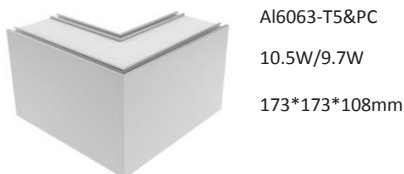

T-type corner(T90-LH73108)



X-type corner (X90-LH73108)

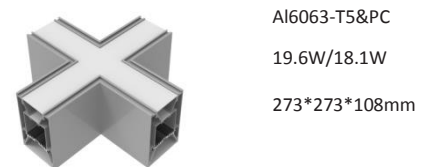

180° extender



\* There are both with light source and light source free options for the three kinds of corners.

# Chain GLH 73108 Series Up/Down LED Linear Light

## Optical Parameter

D8320-24V-34mm driver, frosted diffuser

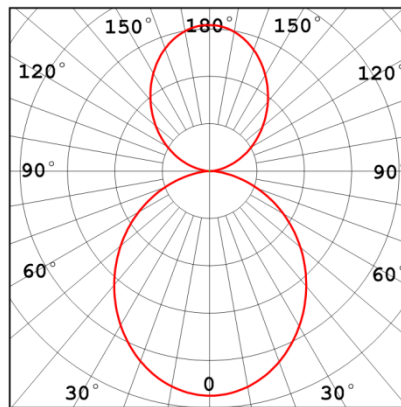
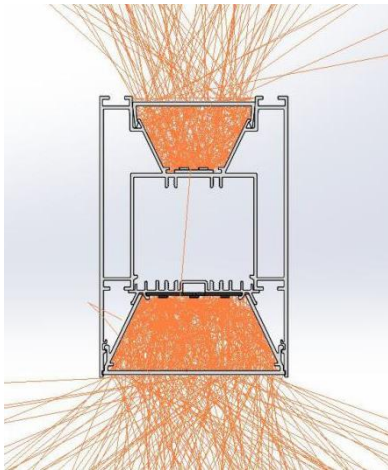

UNIT: cd  
— C0/180, 360.0deg    — C90/270, 360.0deg

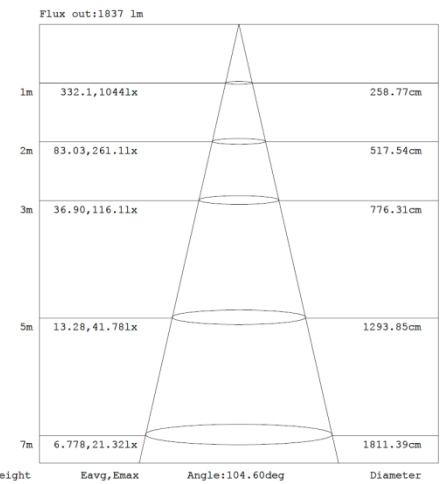

D8320-24V-34mm driver, UGR filter diffuser

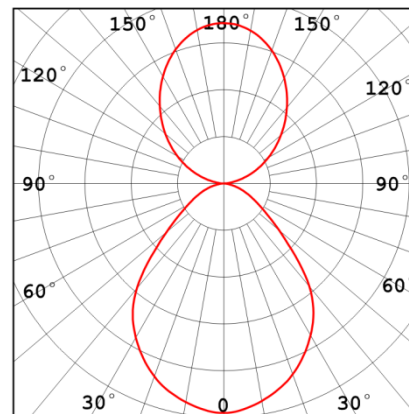
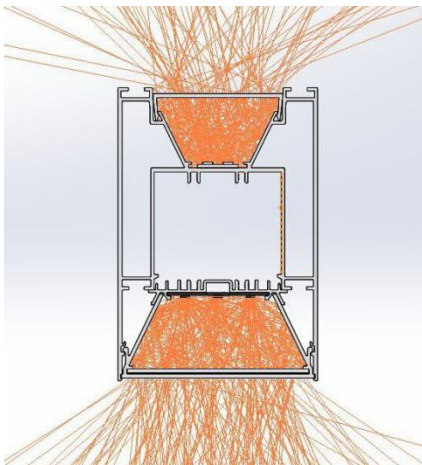



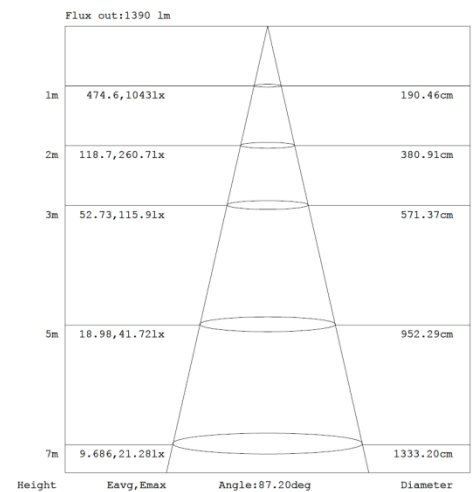











UNIT: cd  
— C0/180, 360.0deg    — C90/270, 225.4deg



# Chain GLH 73108 Series Up/Down LED Linear Light

## Options of Diffuser

Standard product + flexible customisation

Profile (semi-assembled components)								
Opal Diffuser GLH73108DD	Item	Profile	Carrier	Frosted diffuser	Diffuser(one colour)	End cap	Snap joint	Clip
	PIC							
	Amount	1 pcs	1 pcs	1 pcs	1 pcs	End cap *2 pcs	4 pcs	3 pcs
Options	Customisable length: ≤2.5m							
UGR Diffuser GLH73108DP	Item	Profile	Carrier	UGR filter diffuser	Diffuser(one colour)	End cap	Snap joint	Clip
	PIC							
	Amount	1 pcs	1 pcs	1 pcs	1 pcs	End cap *2 pcs	4 pcs	3 pcs
Options	Customisable length: ≤2.5m							