



Surface Mounted Kit

- LED Panel Light

GU-SF-01



Introduction

This surface mounted frame is a DIY version and suitable for both backlit & edge-lit panel, the frame height is 70mm. Easy installation.

Features

- Material AL6063 Aluminum
- Quality powder coated finished White-RAL9016
- Frame height 70mm.

Application Areas

Designed for interior commercial, office lighting projects with surface mounting methods, such as office, meeting room etc.

GU-SF3030-01

Apply to LED panel
295*295mm

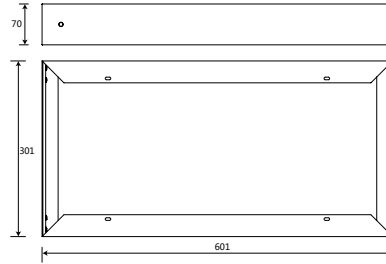
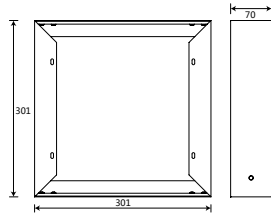

GU-SF3060-01

Apply to LED panel
295*595mm

GU-SF6060-01

Apply to LED panel
595*595mm

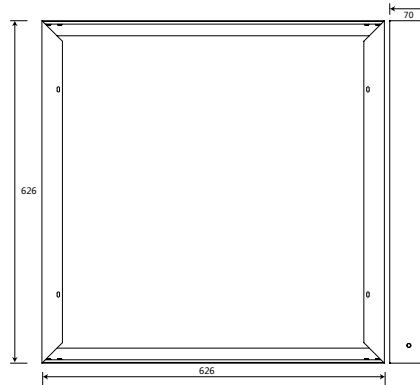
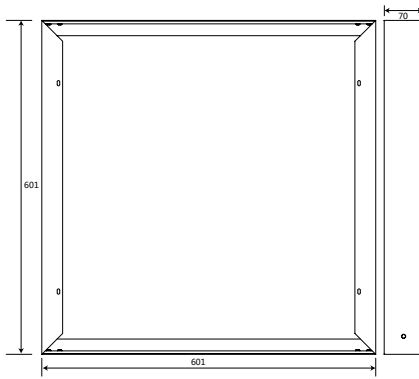

GU-SF6262-01

Apply to LED panel
620*620mm

GU-SF30120-01

Apply to LED panel
295*1195mm

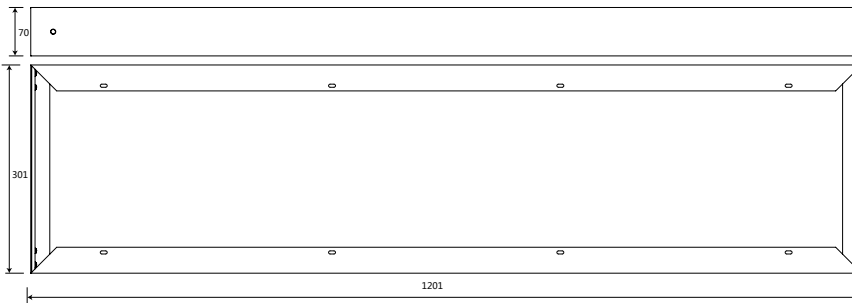

GU-SF60120-01

Apply to LED panel
595*1195mm

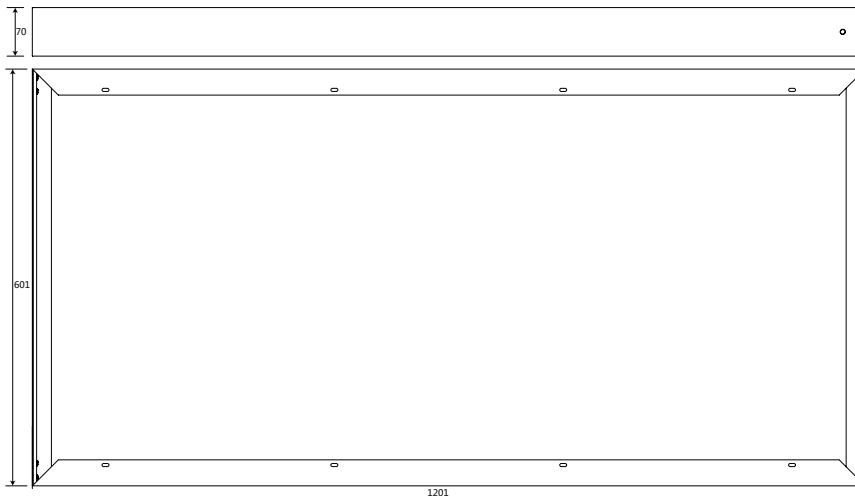

Panel Ceiling Installation Instruction

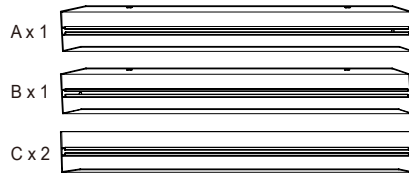

Accessory pack information

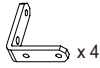

x 4 for 3030/3060/6060/6262 frame

x 8 for 30120/60120 frame

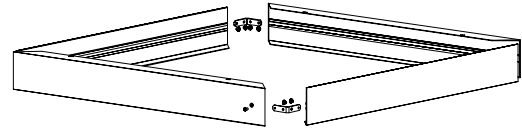

1. Take out the frames (1pc A frame, 1pc B frame, 2pcs C frame), screws (12pcs M4 round screw, 2pcs countersunk screw) and 4pcs corner fittings.

2. Joint the surface mounted frame with corner fittings, C frames must in opposite position.

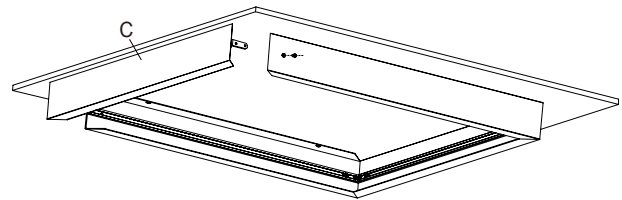
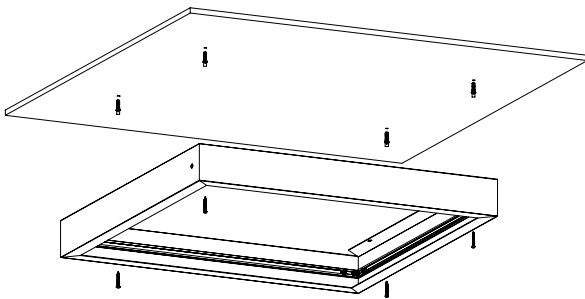

3. Knock the plastic anchor into ceiling, fix the surface mounted frame on the ceiling by screws.

4. Remove one side C frame, take out the corner fitting.

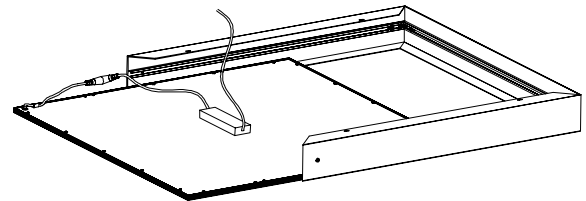
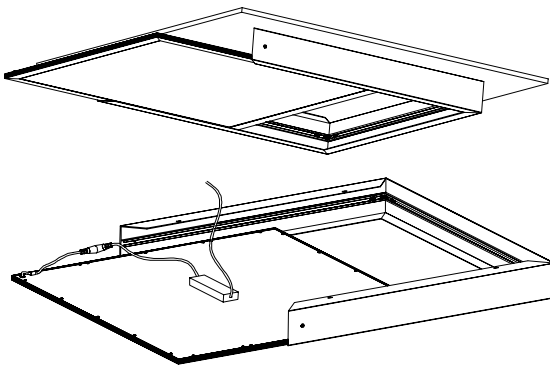

5. Connect panel light to power supply, insert panel light into the frame.

6. Fix side C frame back by screw.

7. Make sure the frame and panel light are firmly fixed, turn on the power.

