

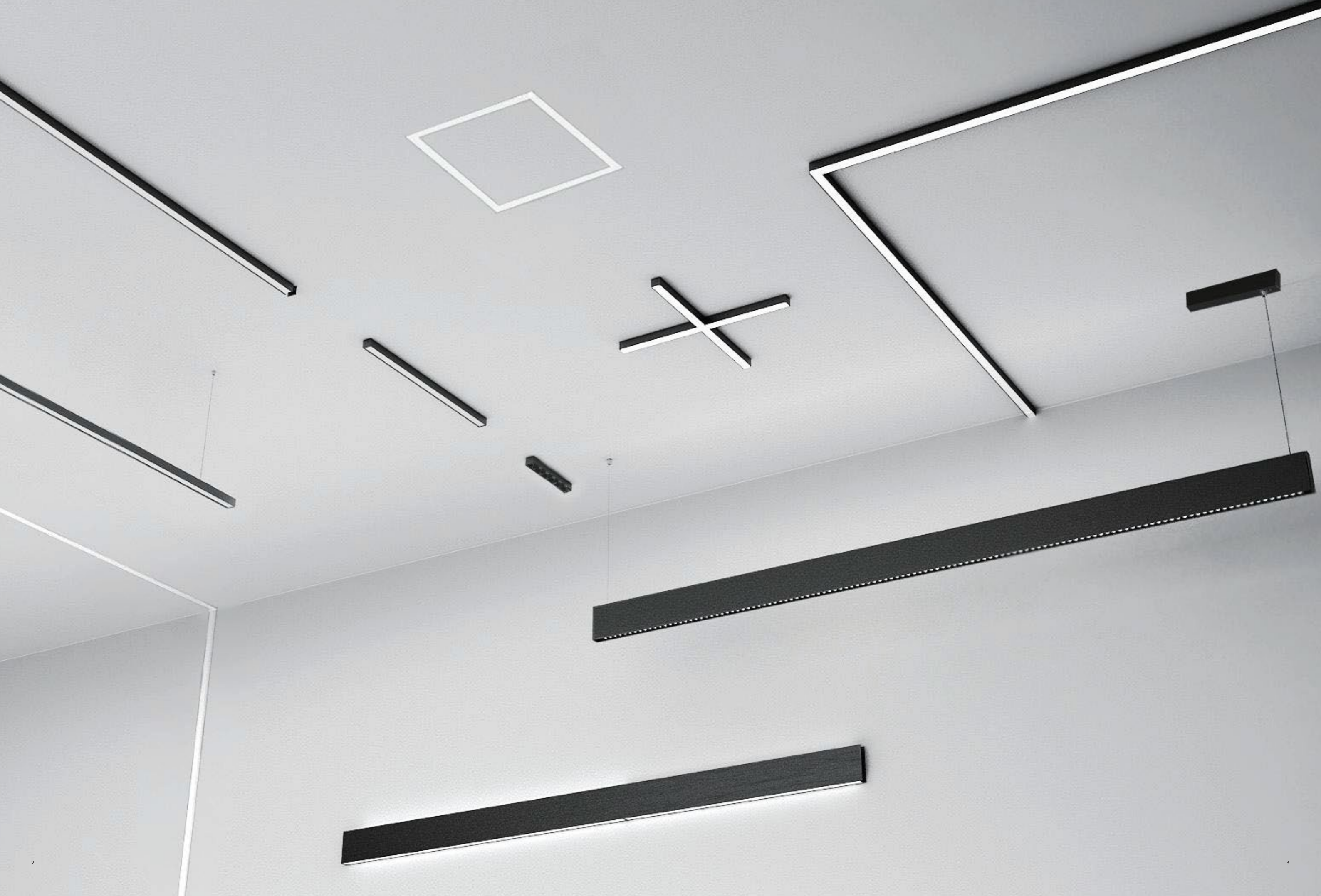

# Chain Slim S25 Series

## LED Linear Light

GLS25/GLM25/GLH25/GLE25/GLR25/GLC25



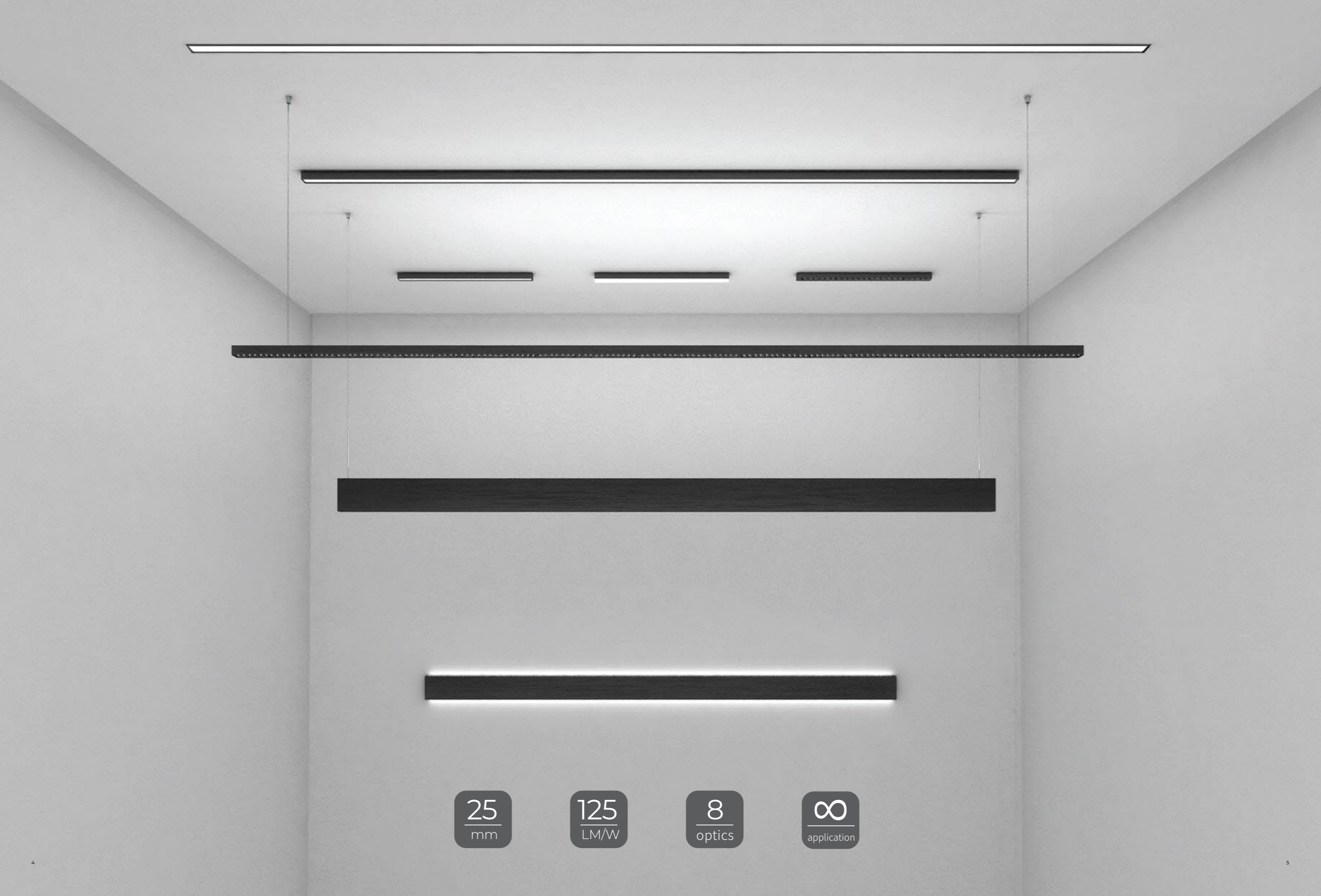

25  
mm

125  
LM/W

8  
optics

∞  
application

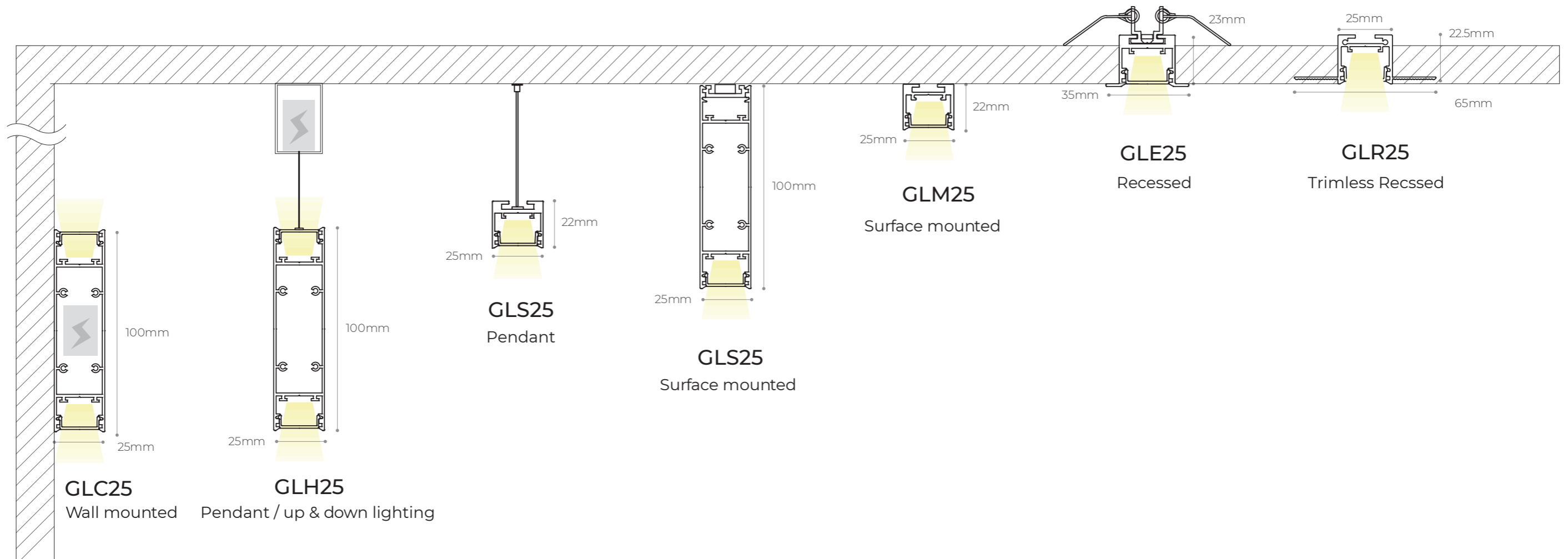

**Length**

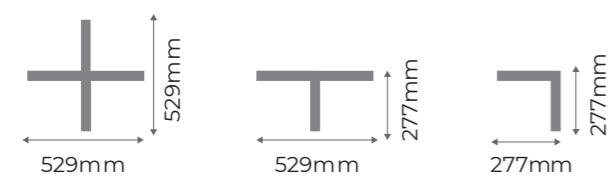
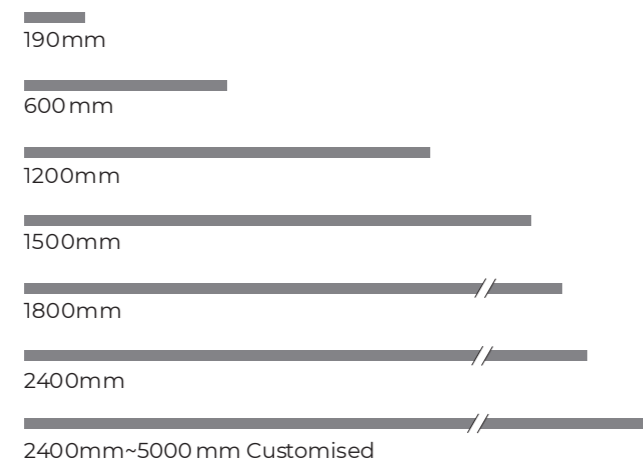

**Optics**

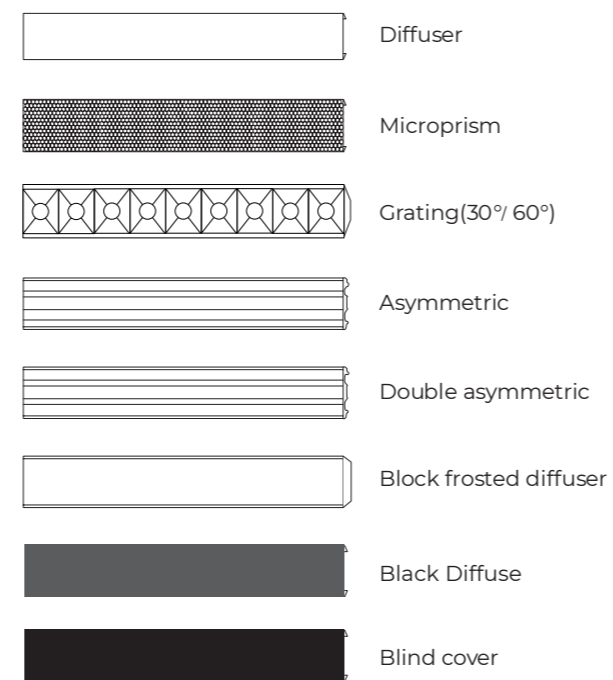

**Connector**

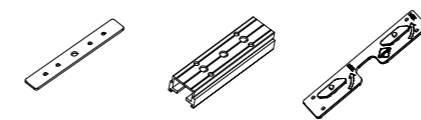

**Installation accessories**



**Power box**



100W Non-dimming 200-240VAC 574x25x50mm  
 100W Dimming 100-277VAC 574x35x60mm

**Finishes**



**Lighting source**





## Multiple light distributions, more choices

Neon track can achieve multiple light distributions, such as diffuser (100°), Prismatic (80°), Grating (30°), Grating (60°), asymmetric (90° x 45° x 15°), double asymmetric (100° x 90°), block frosted diffuser (140°) etc.

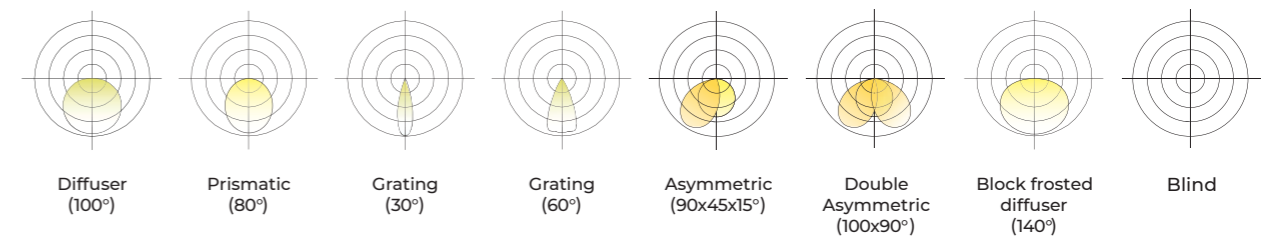

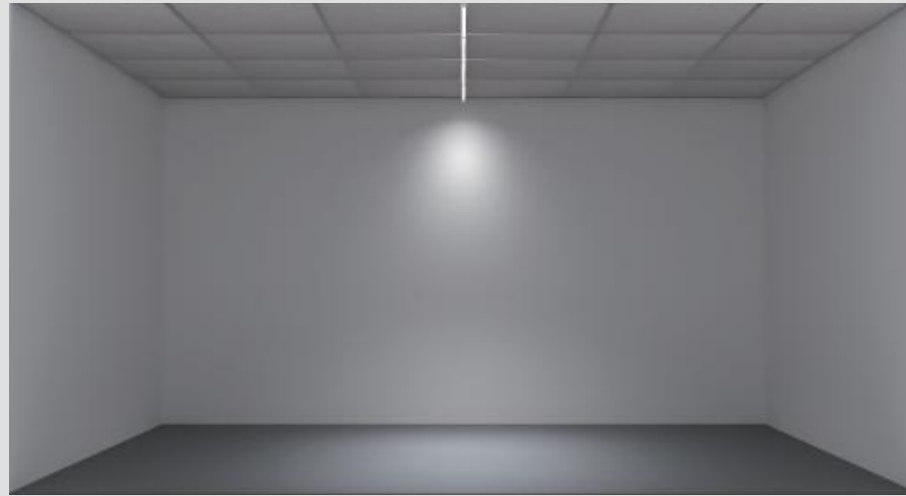

Diffuser

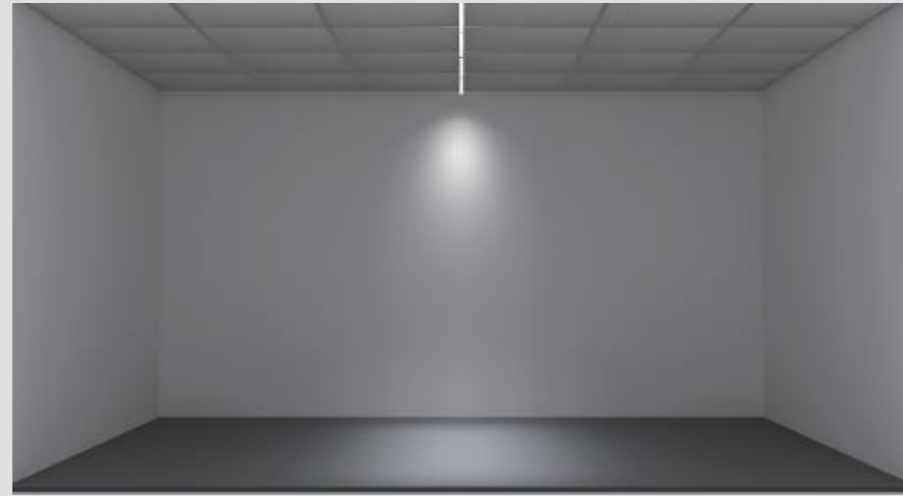

Microprism

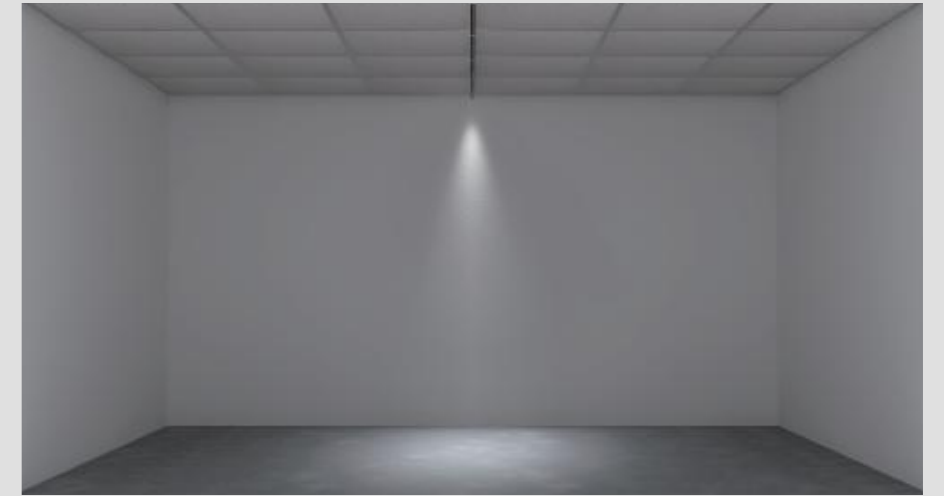

Grating30°



Grating 60°

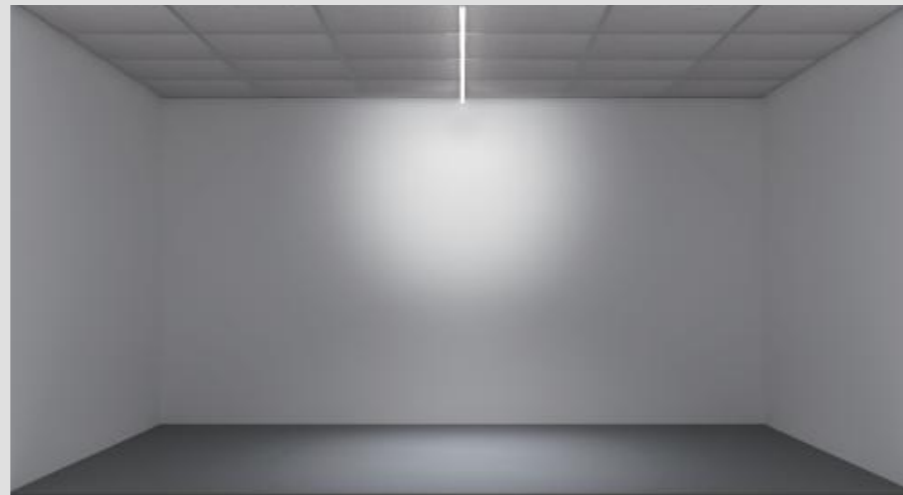

Block frosted diffuser

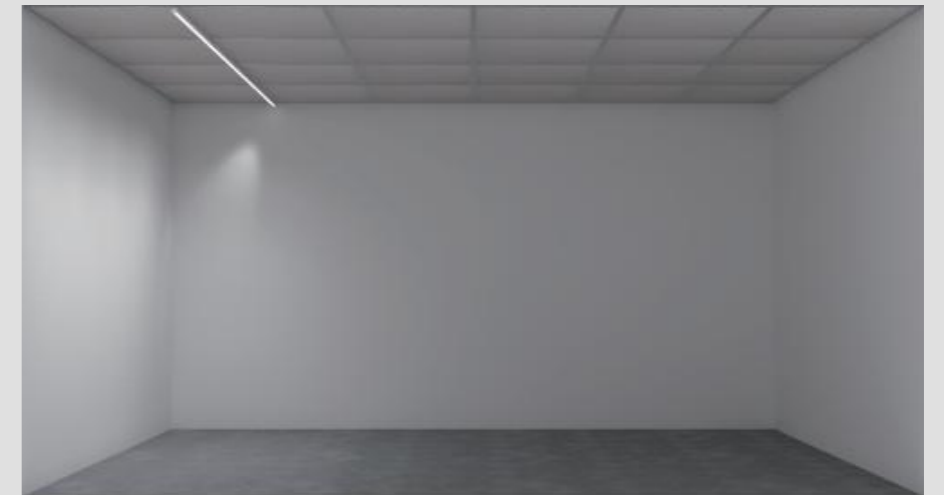

Asymmetric



Double asymmetric

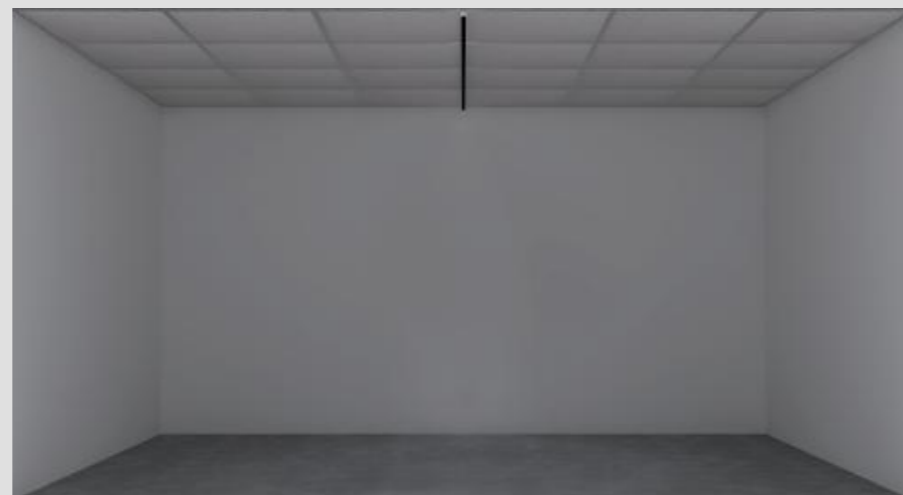

Blind cover

125  
LM/W

2500  
LM/M

High lumen output  
High lighting efficiency

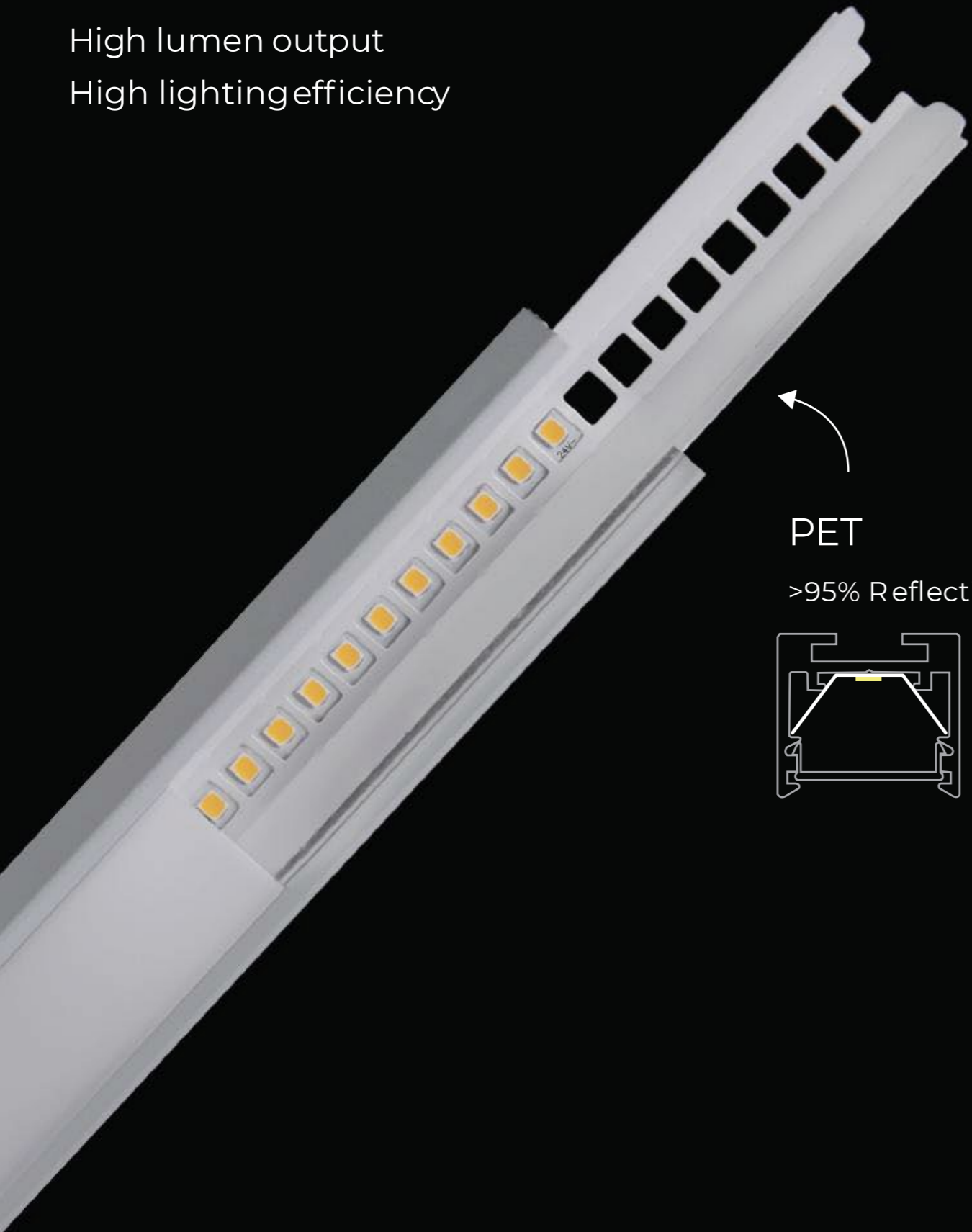

PET  
>95% Reflectivity

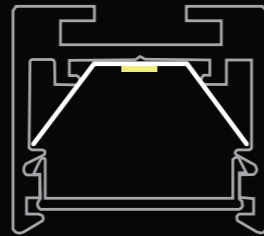

CRI > 80 CRI > 90

2700 K 3000 K 4000 K 5000 K 6500 K

1 BIN ONLY	3 SDCM ≤ 3	Same Forever
------------------	---------------	-----------------

LM-80

Diffuser	Microprism	Grating 30°	Grating 60°	Asymmetric	Double asymmetric	Block frosted diffuser
105 LM/W	105 LM/W	70 LM/W	60 LM/W	125 LM/W	125 LM/W	100 LM/W

\*Base on CRI80 4000K

# Installation-drywal

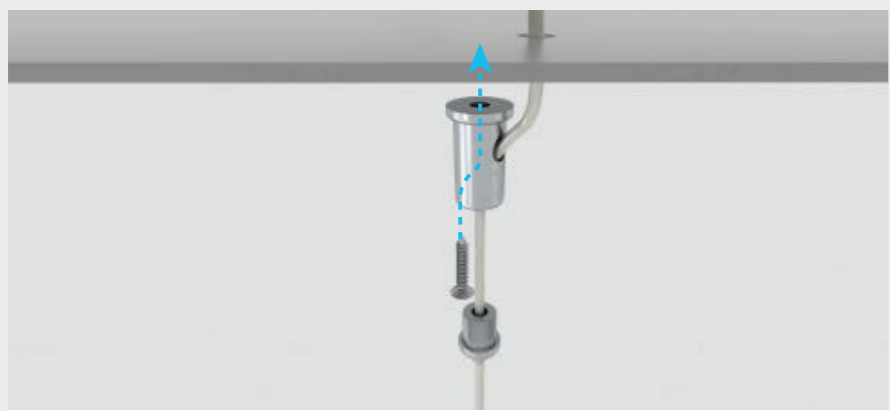
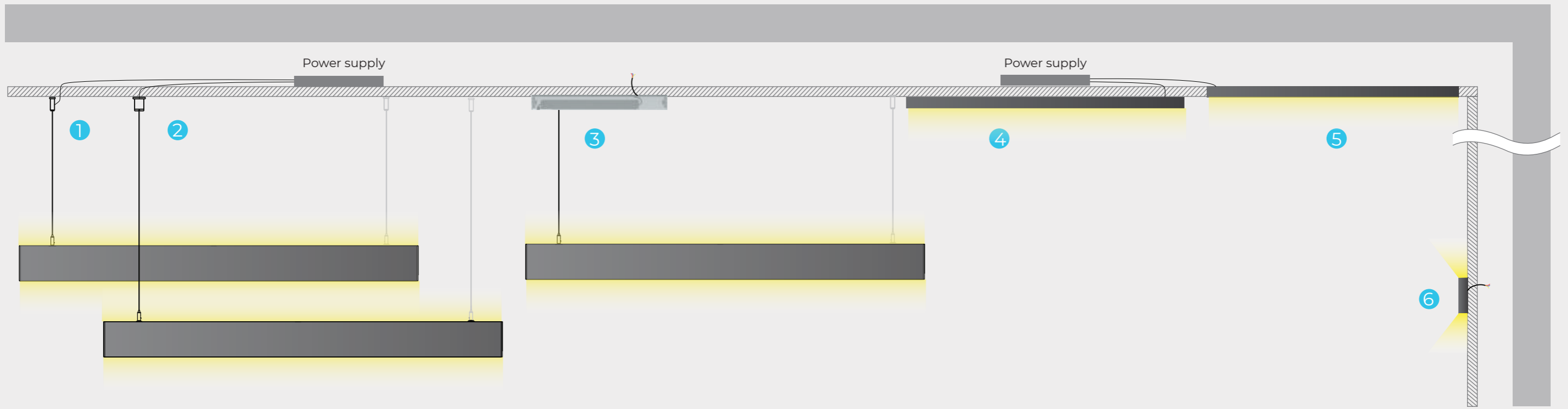

1 Pendant-GLH25/GLS25

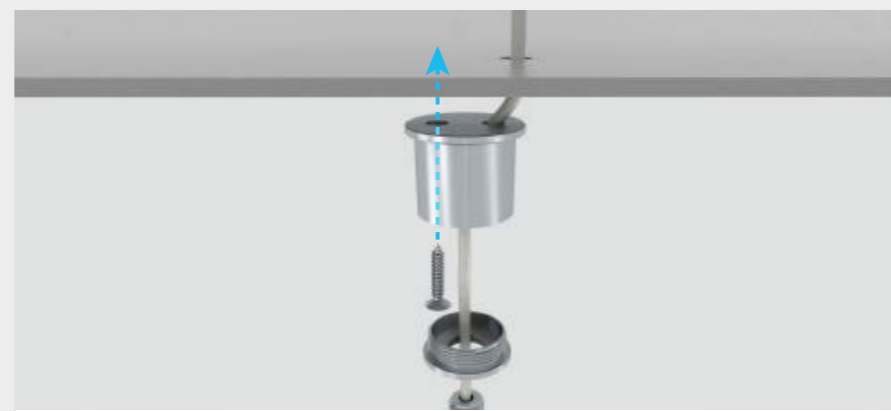

2 Pendant-GLH25/GLS25

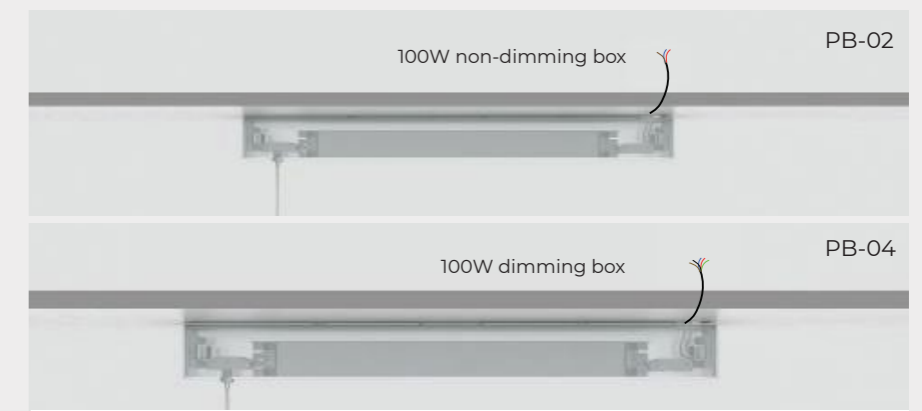

3 Pendant-GLH25/GLS25



4 Surface mounted-GLM25

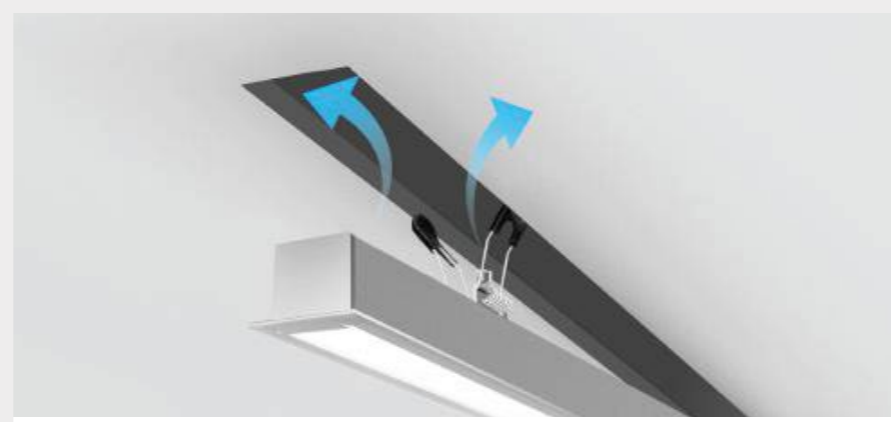

5 Recessed-GLE25

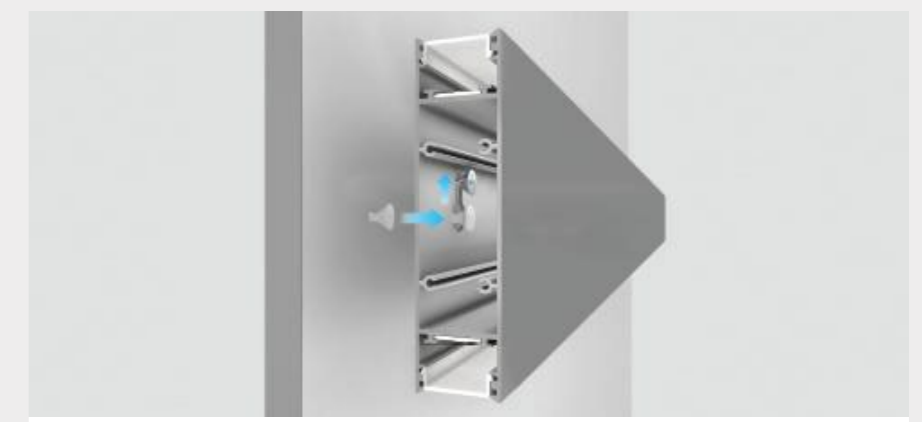

6 Wall mounted-GLC25

# Installation-brick wall

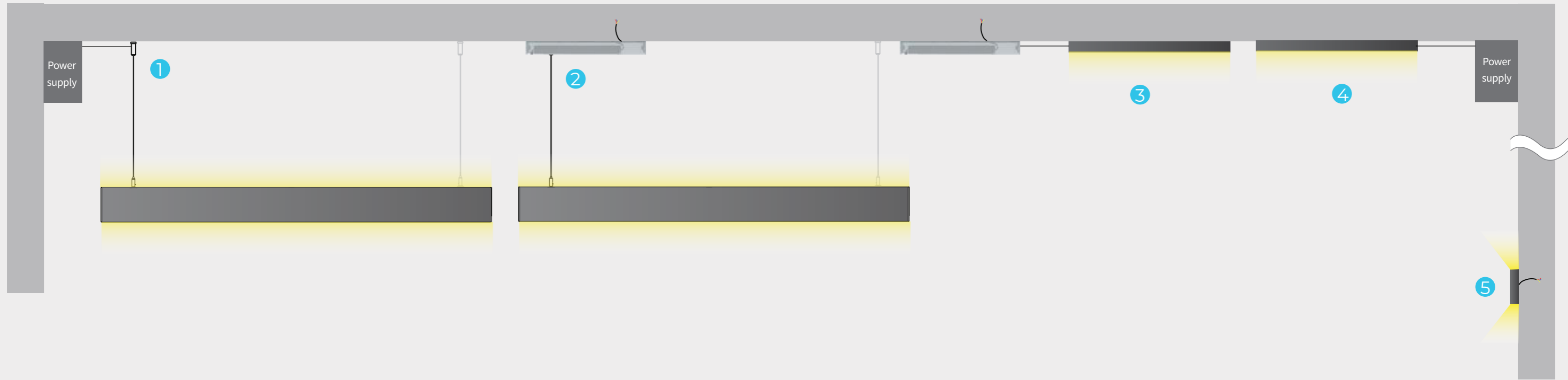

1 Pendant-GLH25/GLS25

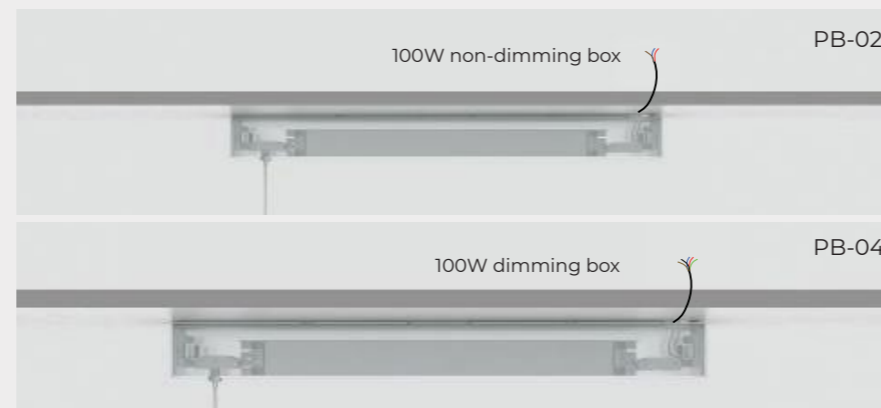

2 Pendant-GLH25/GLS25



3 4 Surface mounted-GLM25

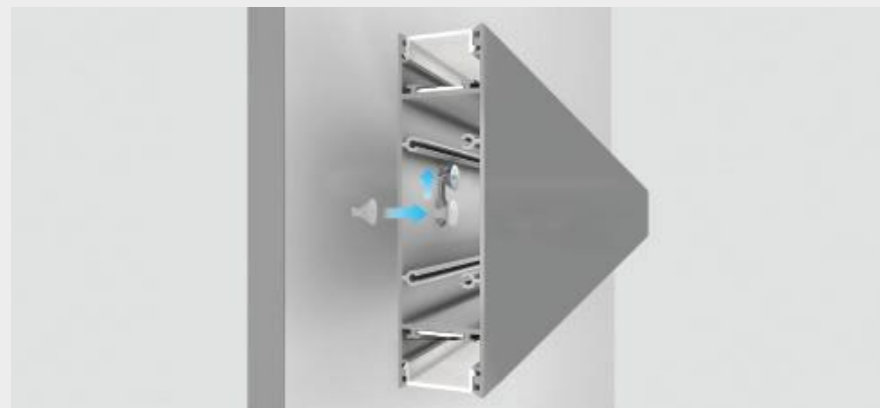

5 Wall mounted-GLC25

# Connection

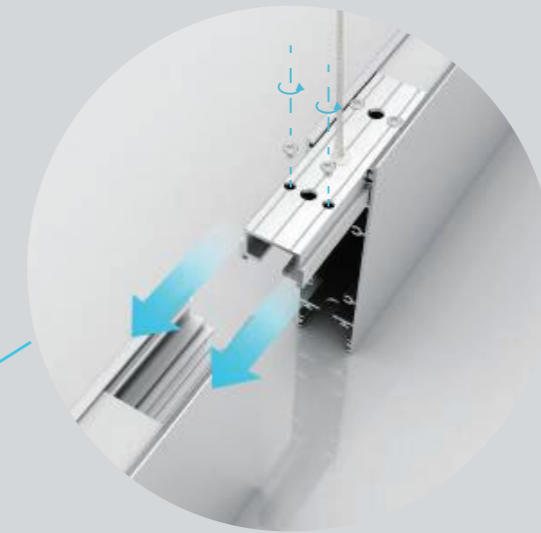
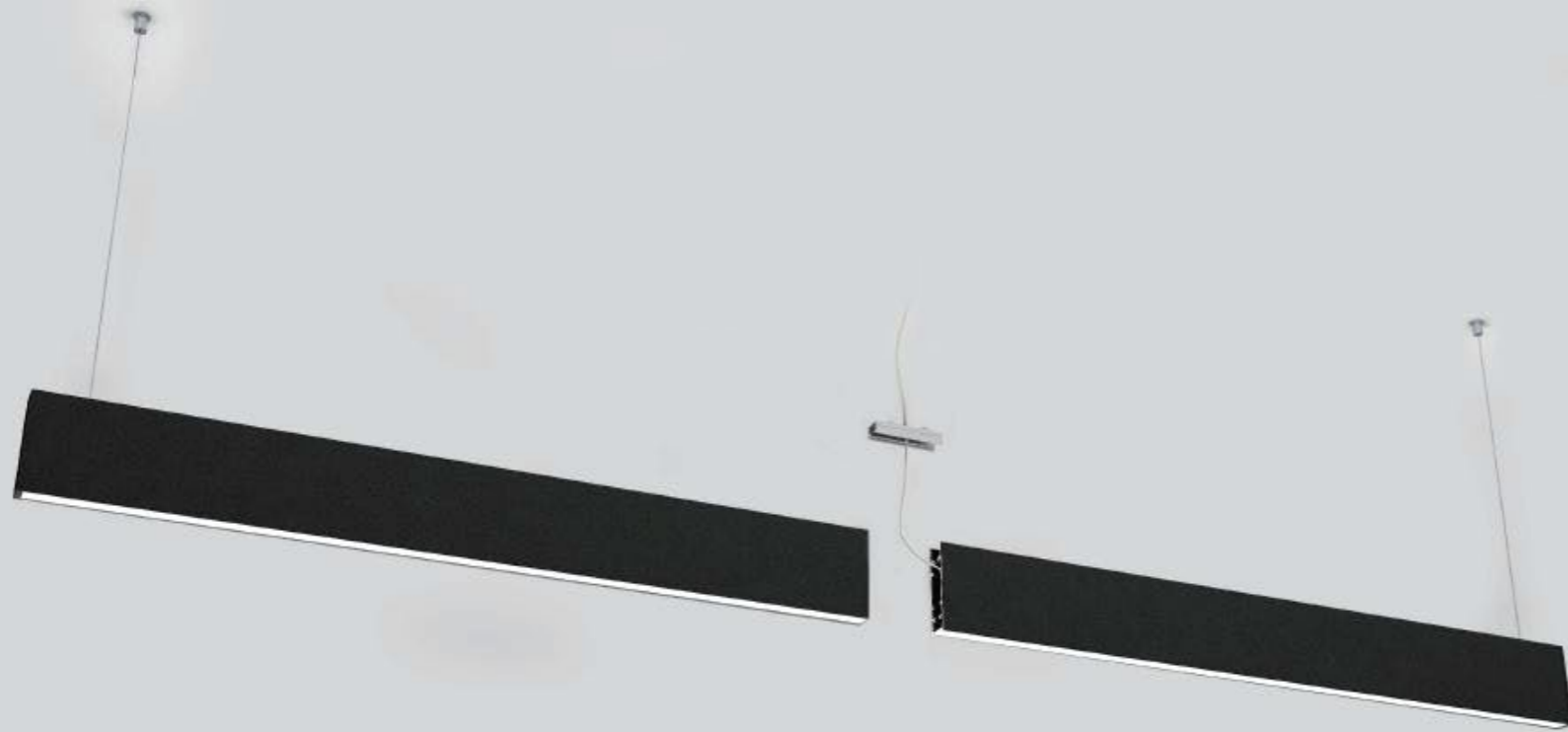

GLH25  
Connection  
(without end cap)

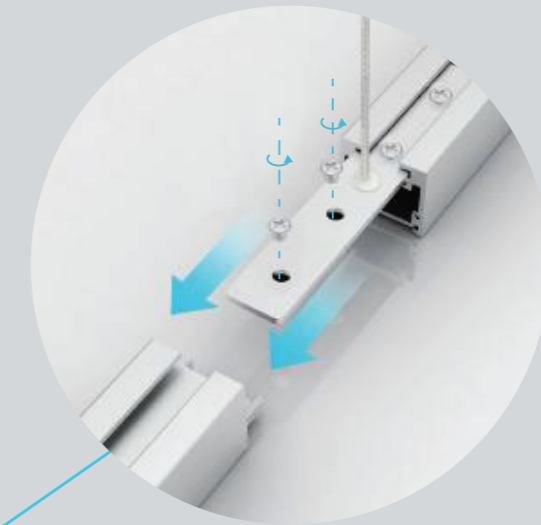
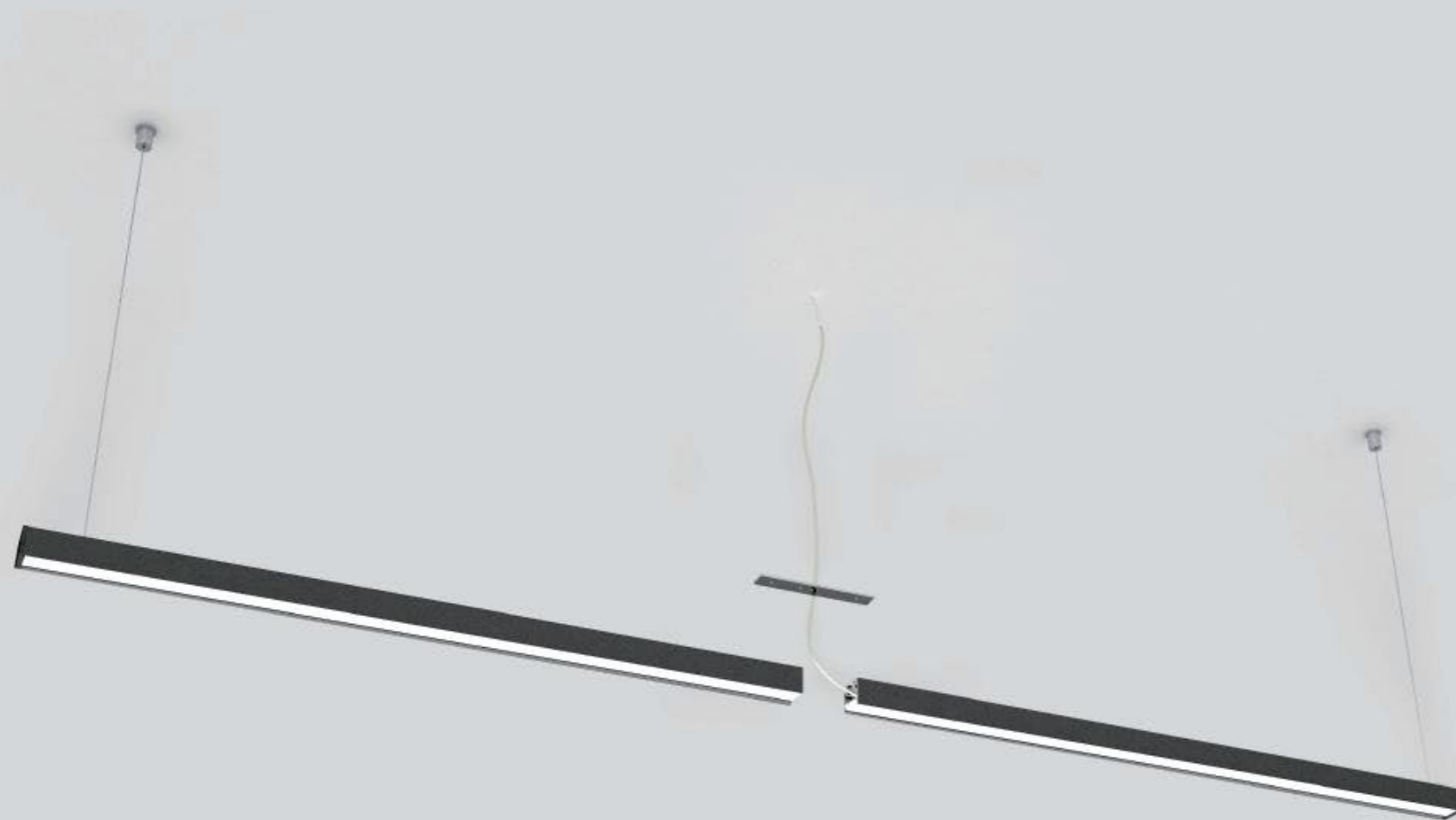

GLS25/GLM25/  
GLE25/GLR25  
Connection  
(without end cap)

only for Diffuser and Microprism

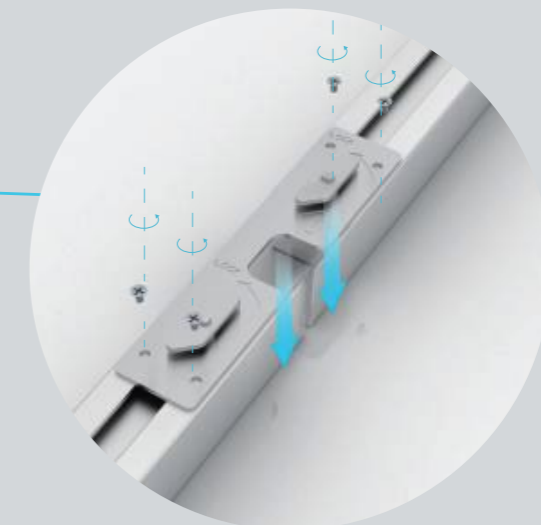

GLS25  
Connection  
(with end cap)

# Corners



GLH25

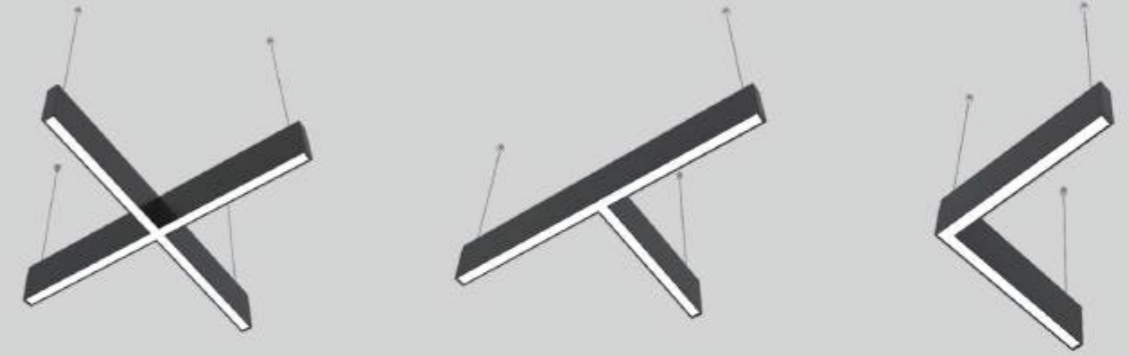

GLS25



GLM25



GLE25



# GLH25 AC 220V

## Up/Down Suspension LED Linear Light



- Standard luminaire, Standard with Power box (built-in Constant current power supply), AC220V Plug-and-Play
- Support no dimming/0-10V/DALI dimming
- Up and down lighting design with suspension way, 25mm slender lighting surface.
- 100Lm/w high light efficiency design, lumen output up to 3800Lm/m.
- Multiple light distribution options(Diffuser, Microprism, Grating 30°, Grating 60°)to meet variety application requirements
- Electric wire& suspension wire with two-in-one design, invisible and beautiful.

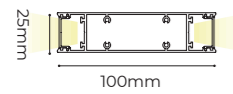

### Basic Parameters

Profile material AL6063-T5

Surface processing Spraying RAL9003  Spraying RAL9005  Anodising

CCT  2700K  3000K  4000K  5000K  6500K

CRI Ra80/Ra90\* (\*only for 2700K/3000K)

	1200mm	1500mm	1800mm	2400mm
<b>Diffuser</b>	Up: 19W / 1700LM Down: 19W / 1900 LM	Up: 23W / 2100LM Down: 23W / 2300 LM	Up: 28W / 2600LM Down: 28W / 2800 LM	Up: 38W / 3600LM Down: 38W / 3800 LM
<b>Microprism</b>	Up: 19W / 1700LM Down: 19W / 1900 LM	Up: 23W / 2100LM Down: 23W / 2300 LM	Up: 28W / 2600LM Down: 28W / 2800 LM	Up: 38W / 3600LM Down: 38W / 3800 LM
<b>Grating 30°</b>	Up: 19 W / 1570 LM Down: 19 W / 1310 LM	Up: 23W / 1900 LM Down: 23W / 1590 LM	Up: 28W / 2200 LM Down: 28W / 1930 LM	Up: 38W / 3150 LM Down: 38W / 2620 LM
<b>Grating 60°</b>	Up: 19 W / 1570 LM Down: 19 W / 1080 LM	Up: 23W / 1900 LM Down: 23W / 1330 LM	Up: 28W / 2200 LM Down: 28W / 1590 LM	Up: 38W / 3150 LM Down: 38W / 2150 LM

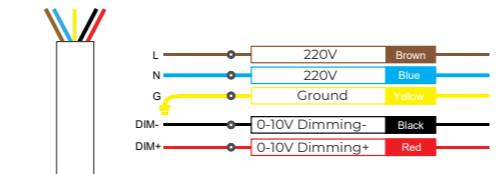

### Model Number

Model	Series	Section Size	Diffuser Shape	Diffuser Nature	Carrier Style	Profile Colour	End Cap Style	Length	Light Source Type	Light Source Power	CCT	CRI	Power Type
GCCHA-GLH25-38W-4F	LLS - Pendant Lighting upward& downward	GLH 25	Flat F	Diffuser D	NO Carrier X	Silver S	Holeless end cap S	1200mm	Constant Current Rigid T	38W 38	2700K SW	>80 B	Support no dimming N
GCCHA-GLH25-46W-5F				Micro-prism P		White W		1500mm		46W 46	3000K WW	>90 9	0-10V B
GCCHA-GLH25-54W-6F				30° F		Black B		1800mm		54W 54	4000K NW		DALI dimming A
GCCHA-GLH25-76W-8F				60° H				2400mm		76W 76	5000K DW		
										6500K W			



# GLS25 **AC 220V** Suspension LED Linear Light



- Standard luminaire, Standard with Power box ( built-in Constant current power supply ), AC220V Plug-and-Play.
- Support no dimming/0-10V/DALI dimming.
- 25mm slender lighting surface.
- 100Lm/w high light efficiency design, lumen output up to 1700Lm/m.
- Multiple light distribution options(Diffuser, Microprism, Grating30°, Grating 60°, Block frosted diffuser) to meet variety application requirements.
- Electric wire & suspension wire with two-in-one design, invisible and beautiful.

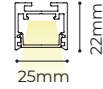
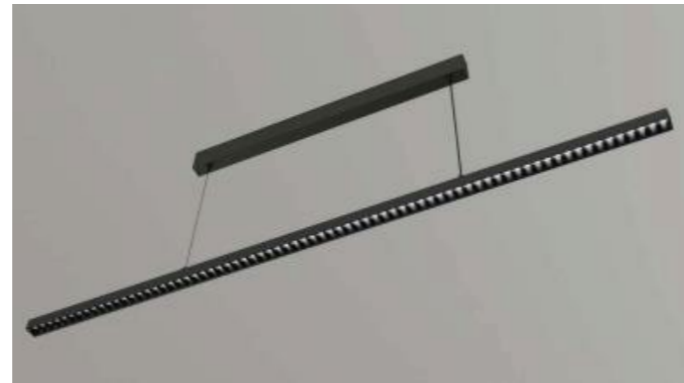

## Basic Parameters

Profile material AL6063-T5

Surface processing  Spraying RAL9003  Spraying RAL9005  Anodising

CCT  2700K  3000K  4000K  5000K  6500K

CRI Ra80/Ra90\* (\*only for 2700K/3000K)

	1200mm	1500mm	1800mm	2400mm
Diffuser	20W/2000LM	29W/2500LM	38W/3000LM	46W/4000LM
Microprism	20W/2000LM	29W/2500LM	38W/3000LM	46W/4000LM
Grating 30°	20W/1660LM	29W/2070LM	38W/2480LM	46W/3310LM
Grating 60°	20W/1360LM	29W/1700LM	38W/2030LM	46W/2720LM
Block frosted diffuser	20W/1830LM	29W/2290LM	38W/2750LM	46W/3660LM

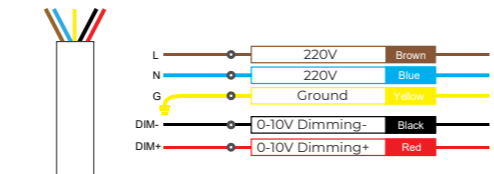

## Model Number

Model	Series	Section Size	Diffuser Shape	Diffuser Nature	Carrier Style	Profile Colour	End Cap Style	Length	Light Source Type	Light Source Power	CCT	CRI	Power Type	
GCCHA-GLS25-20W-4F	LLS - Pendant	CLS 25	Flat	Diffuser	NO Carrier	Silver	Holeless end cap	1200mm	Constant Current Rigid	20W	2700K	>80	Support no dimming	
GCCHA-GLS25-29W-5F				Micro-prism	Carrier	White		1500mm		29W	3000K	>90	0-10V	
GCCHA-GLS25-38W-6F				Square	30°		Black		1800mm		38W	4000K		DALI dimming
GCCHA-GLS25-46W-8F					60°				2400mm		46W	5000K		
	LLS -	CLS 25	F	D	X	S	S	2400	T	46	LW	B	B -	



# GLC25 **AC 220V**

## LED Wall Light



- Up and down lighting design with wall mounted way, 25mm slender lighting surface.
- Support no dimming/0-10V/DALI dimming
- Germany brand PC diffuser with uniform and soft light output
- Built-in power, invisible and beautiful.

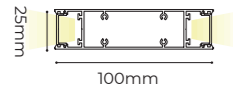
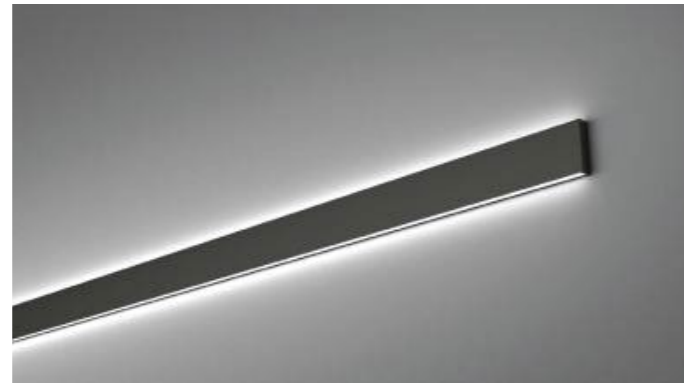

### Basic Parameters

Profile material AL6063-T5

Surface processing  Spraying RAL9003  Spraying RAL9005  Anodising

CCT  2700K  3000K  4000K  5000K  6500K

CRI Ra80/Ra90\* (\*only for 2700K/3000K)

	600mm	1200mm	1500mm	1800mm	2400mm
Diffuser	Up: 7W/540LM Down: 7W/540LM	Up: 14W/1070LM Down: 14W/1070LM	Up: 19W/1340LM Down: 19W/1340LM	Up: 23W/1600LM Down: 23W/1600LM	Up: 29W/2140LM Down: 29W/2140LM

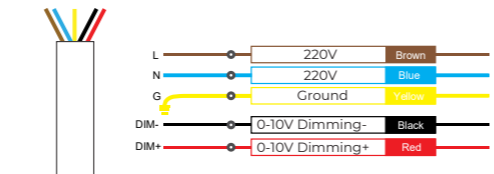

### Model Number

Model	Series	Section Size	Diffuser Shape	Diffuser Nature	Carrier Style	Profile Colour	End Cap Style	Length	Light Source Type	Light Source Power	CCT	CRI	Power Type					
GCCHA-GLC25-14W-2F GCCHA-GLC25-28W-4F GCCHA-GLC25-39W-5F GCCHA-GLC25-46W-6F GCCHA-GLC25-58W-8F	Wall mounted Lighting upward& downward	GLC 25	Flat	F	Diffuser D	NO Carrier	X	Silver S	Holeless end cap	S	600mm	Constant Current Rigid	T	14W 14	2700K SW	>80 8	Support no dimming	N
White W								1200mm						28W 28	3000K WW	>90 9	0-10V	B
Black B								1500mm						39W 39	4000K NW		DALI dimming	A
								1800mm						46W 46	5000K DW			
								2400mm						58W 58	6500K W			

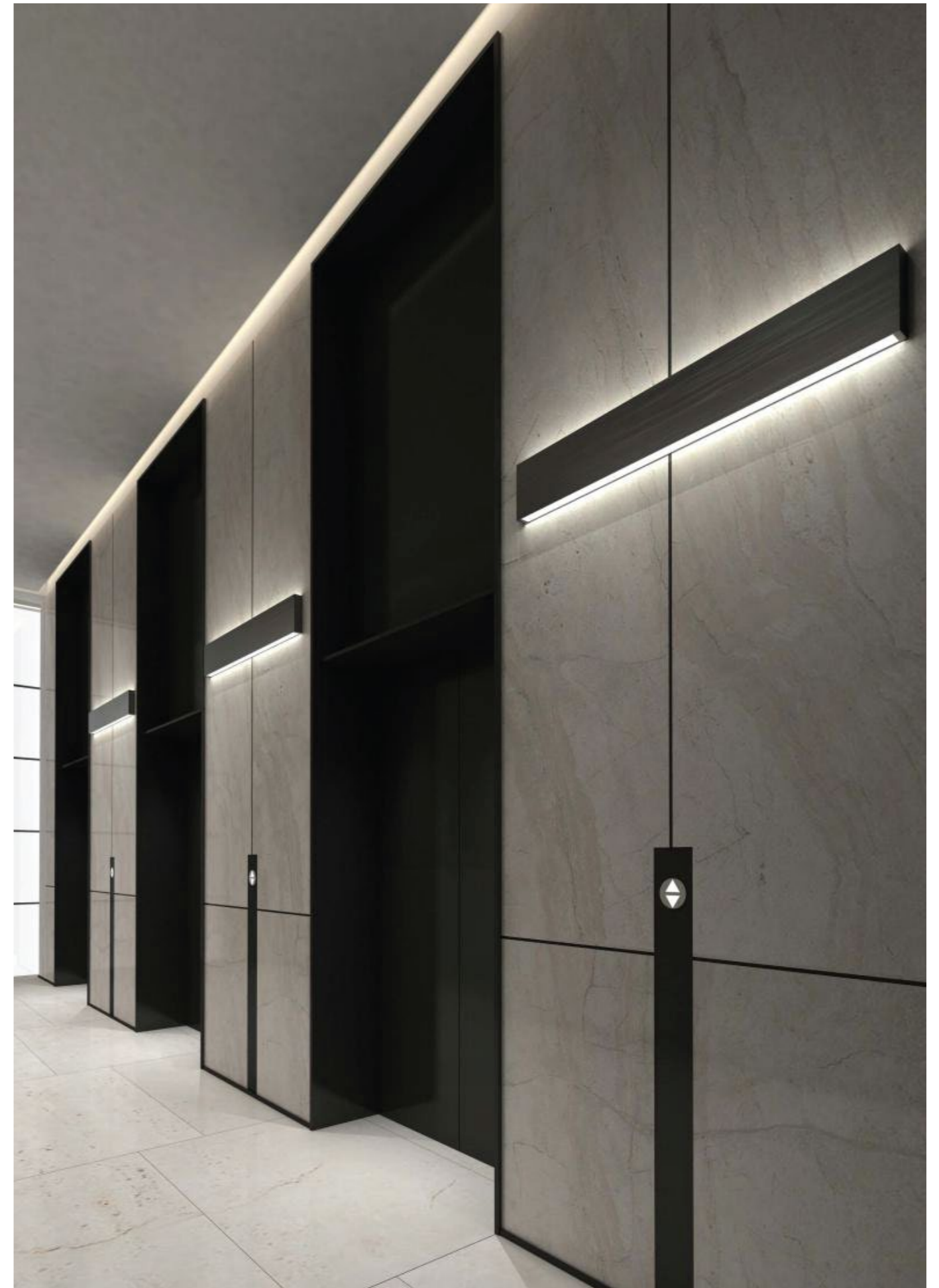

# GLH25 DC 24V

## Up/Down Suspension LED Linear Light



- Up and down lighting design with suspension way, 25mm slender lighting surface.
- 105Lm/w high light efficiency design, lumen output up to 4200Lm/m.
- Multiple standard corner(L type, X type, T type optional) available for free connection.
- Multiple light distribution options ( Diffuser, Microprism, Grating 30°, Grating 60° ) to meet variety application requirements.
- Electric wire & suspension wire with two-in-one design, invisible and beautiful.

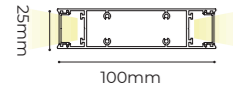
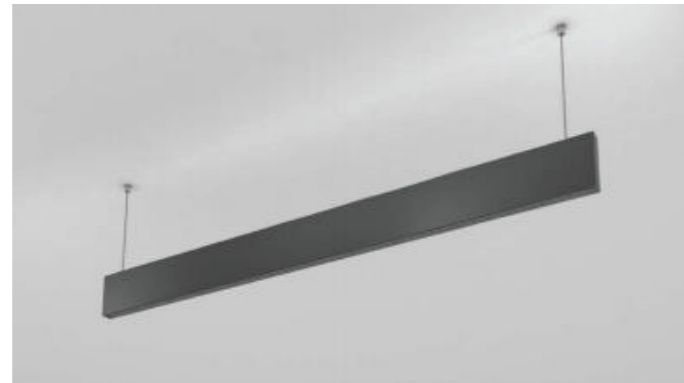

□ Diffuser/Microprism   ▨ Grating 30°/60°   ■ Blind cover

### Standard length

600mm			2400mm
1200mm			1800mm
1500mm			1500mm
1800mm			1200mm
2400mm			600mm

### Basic Parameters

Profile material AL6063-T5

Surface processing  Spraying RAL9003  Spraying RAL9005  Anodising

CCT  2700K  3000K  4000K  5000K  6500K

CRI Ra80/Ra90\* (\*only for 2700K/3000K)

	600mm	1200mm	1500mm	1800mm	2400mm	L*(277*277mm)	T*(529*277mm)	X*(529*529mm)
<b>Diffuser</b>	Up: 12W/950LM Down: 12W/1250LM	Up: 24W/1900LM Down: 24W/2500LM	Up: 30W/2400LM Down: 30W/3150LM	Up: 36W/2900LM Down: 36W/3750LM	Up: 48W/3850LM Down: 48W/5000LM	Up: 11W/880LM Down: 11W/1155LM	Up: 16W/1280LM Down: 16W/1680LM	Up: 21W/1680LM Down: 21W/2205LM
<b>Microprism</b>	Up: 12W/950LM Down: 12W/1250LM	Up: 24W/1900LM Down: 24W/2500LM	Up: 30W/2400LM Down: 30W/3150LM	Up: 36W/2900LM Down: 36W/3750LM	Up: 48W/3850LM Down: 48W/5000LM	Up: 11W/880LM Down: 11W/1155LM	Up: 16W/1280LM Down: 16W/1680LM	Up: 21W/1680LM Down: 21W/2205LM
<b>Grating 30°</b>	Up: 12W/950LM Down: 12W/850LM	Up: 24W/1900LM Down: 24W/1700LM	Up: 30W/2400LM Down: 30W/2100LM	Up: 36W/2900LM Down: 36W/2500LM	Up: 48W/3850LM Down: 48W/3500LM	/	/	/
<b>Grating 60°</b>	Up: 12W/950LM Down: 12W/700LM	Up: 24W/1900LM Down: 24W/1400LM	Up: 30W/2400LM Down: 30W/1800LM	Up: 36W/2900LM Down: 36W/2300LM	Up: 48W/3850LM Down: 48W/3100LM	/	/	/
<b>Blind cover</b>	/	/	/	/	/	Available	Available	Available

### Customised length (2400mm ~ 5000mm)

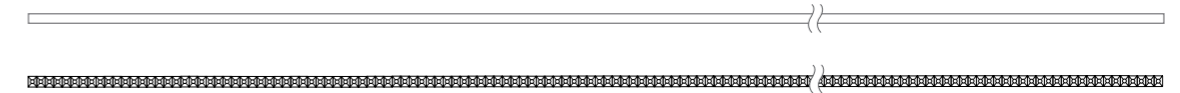

### Ultra long connection (> 5000mm)

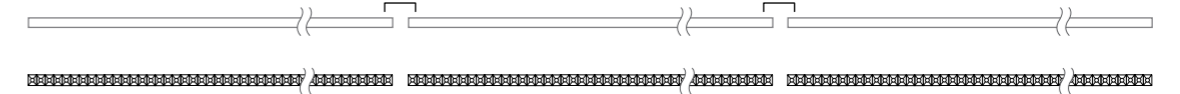

### Corners

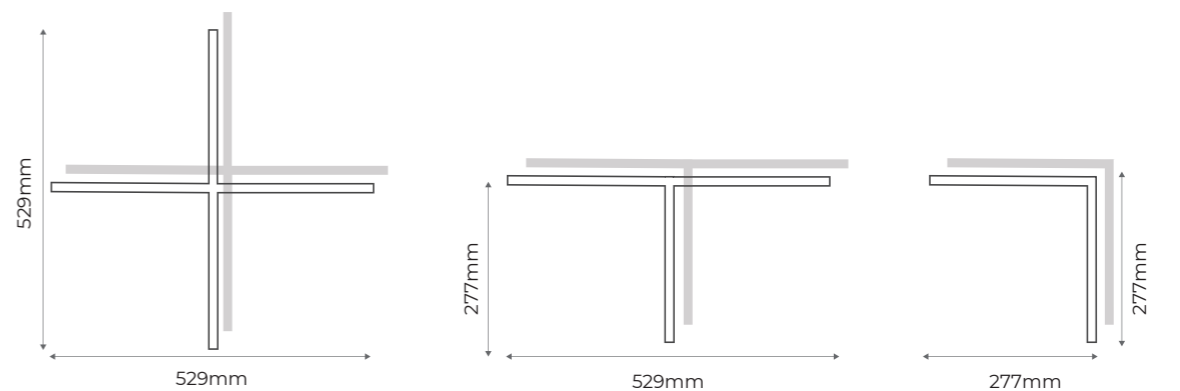

### Model Number

Model	Series	Section Size	Diffuser Shape	Diffuser Nature	Carrier Style	Profile Colour	End Cap Style	Length	Light Source Type	Light Source Power	CCT	CRI	Power Type		
GCCHA-GLH25-24W-2F	LLS - Pendant Lighting upward & downward	GLH 25	Flat F	Diffuser D	NO Carrier X	Silver S	Holeless end cap S	600mm	24VDC flexible strip F	24W	24	2700K	SW	>80 8	24V DC External Driver X
GCCHA-GLH25-48W-4F								1200mm		48W	48	3000K	WW	>90 9	
GCCHA-GLH25-60W-5F								1500mm		60W	60	4000K	NW		
GCCHA-GLH25-72W-6F								1800mm		72W	72	5000K	DW		
GCCHA-GLH25-96W-8F								2400mm		96W	96	6500K	W		
			Grating G	Micro-prism P		White W			24VDC Rigid module R						
				30° F		Black B									
				60° H											

# GLS25 DC 24V

## Suspension LED Linear Light



- 25mm slender lighting surface.
- 105Lm/w high light efficiency design, lumen output up to 2100Lm/m.
- Multiple standard corner ( L type, X type, T type optional) available for free connection.
- Multiple light distribution options (Diffuser, Microprism, Grating 30°, Grating 60°, Block frosted diffuser) to meet variety application requirements.
- Electric wire & suspension wire with two-in-one design, invisible and beautiful.

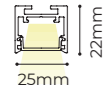
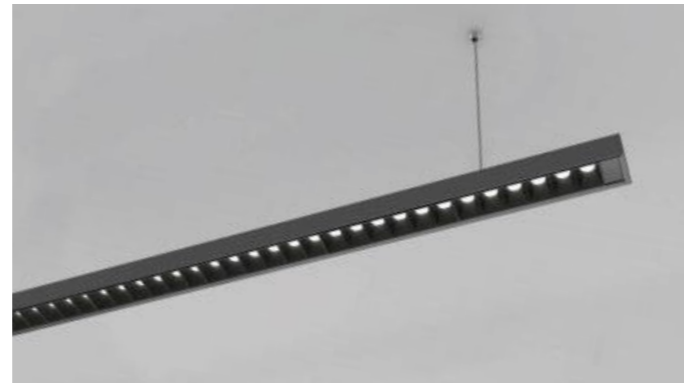

### Basic Parameters

Profile material AL6063-T5

Surface processing  Spraying RAL9003  Spraying RAL9005  Anodising

CCT  2700K  3000K  4000K  5000K  6500K

CRI Ra80/Ra90\* (\*only for 2700K/3000K)

	600mm	1200mm	1500mm	1800mm	2400mm	L*(277*277mm)	T*(529*277mm)	X*(529*529mm)
Diffuser	12W/1250LM	24W/2500LM	30W/3150LM	36W/3750LM	48W/5000LM	11W/1155LM	16W/1680LM	21W/2205LM
Microprism	12W/1250LM	24W/2500LM	30W/3150LM	36W/3750LM	48W/5000LM	11W/1155LM	16W/1680LM	21W/2205LM
Grating 30°	12W/850LM	24W/1700LM	30W/2100LM	36W/2500LM	48W/3500LM	/	/	/
Grating 60°	12W/700LM	24W/1400LM	30W/1800LM	36W/2300LM	48W/3100LM	/	/	/
Block frosted diffuser	12W/1200LM	24W/2400LM	30W/3000LM	36W/3600LM	48W/4800LM	/	/	/
Blind cover	/	/	/	/	/	Available	Available	Available

### Model Number

Model	Series	Section Size	Diffuser Shape	Diffuser Nature	Carrier Style	Profile Colour	End Cap Style	Length	Light Source Type	Light Source Power	CCT	CRI	Power Type												
GCCHA-GLS25-12W-2F GCCHA-GLS25-24W-4F GCCHA-GLS25-30W-5F GCCHA-GLS25-36W-6F GCCHA-GLS25-48W-8F	LLS	Pendant	GLS	25	Flat	F	Diffuser	D	NO Carrier	X	Silver	S	Holeless end cap	S	600mm	24VDC flexible strip	F	12W	12	2700K	SW	>80	8	24V DC External Driver	X
					Grating	G	Micro-prism	P	Carrier	F	White	W			1200mm	24VDC Rigid module	R	24W	24	3000K	WW	>90	9		
					Square	K	30°	F			Black	B			1500mm			30W	30	4000K	NW				
							60°	H							1800mm			36W	36	5000K	DW				
															2400mm			48W	48	6500K	W				
	LLS		GLS	25	F	D	X	S	S	2400		F	48	NW	8	X									

□ Diffuser/Microprism/Block frosted diffuser    ▨ Grating 30°/60°    ■ Blind cover

### Standard length

600mm			2400mm
1200mm			1800mm
1500mm			1500mm
1800mm			1200mm
2400mm			600mm
600mm			
1200mm			
1500mm			
1800mm			
2400mm			

### Customised length (2400mm ~ 5000mm)

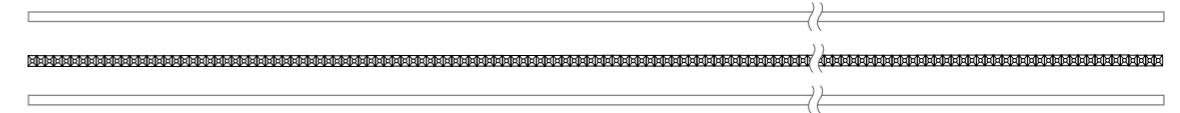

### Ultra long connection (> 5000mm)

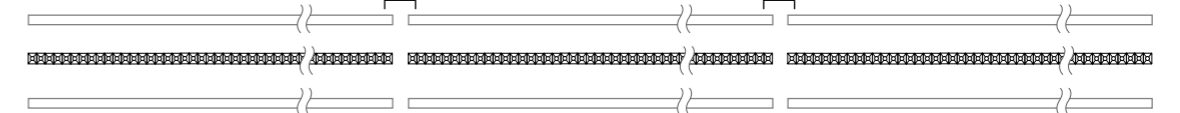

### Corners

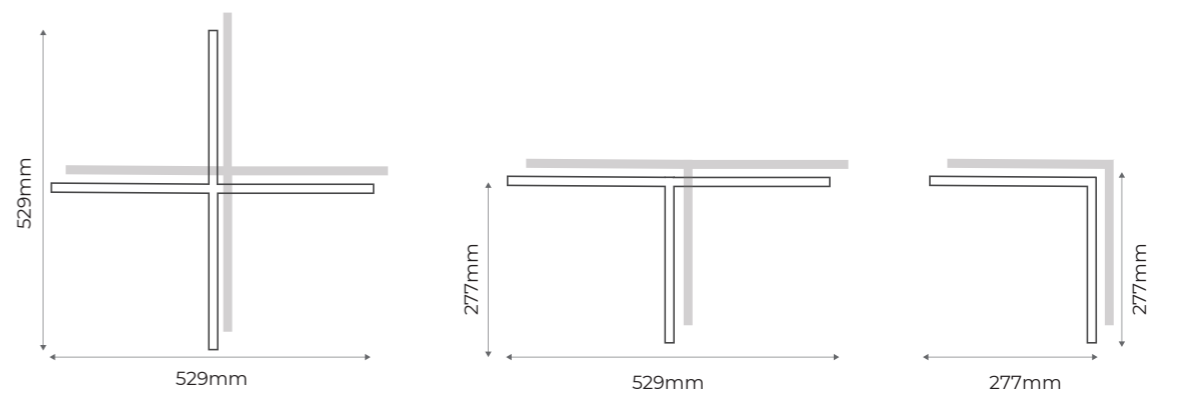

# GLM25 DC 24V

## Surface Mounted LED Linear Light



- 25mm slender lighting surface.
- 125Lm/w high light efficiency design, lumen output up to 2300Lm/m.
- Multiple standard corner ( L type, X type, T type optional ) available for free connection.
- Multiple light distribution options (Diffuser, Microprism, Grating 30°, Grating 60°, Block frosted diffuser, Asymmetric, Double Asymmetric) to meet variety application requirements.
- Provide surface mounted buckle, more convenient installation.

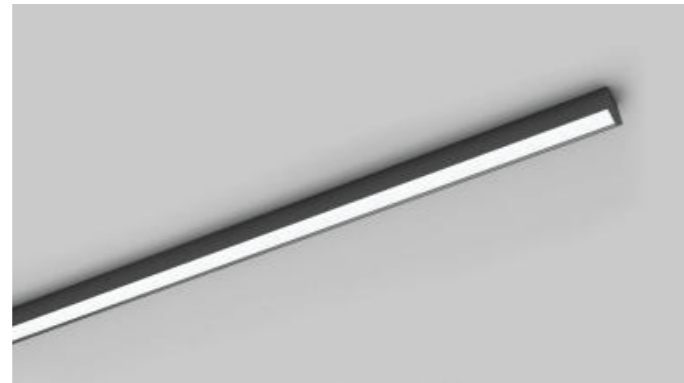
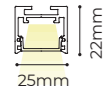

### Basic Parameters

Profile material AL6063-T5

Surface processing  Spraying RAL9003  Spraying RAL9005  Anodising

CCT  2700K  3000K  4000K  5000K  6500K

CRI Ra80/Ra90\* (\*only for 2700K/3000K)

	190mm	600mm	1200mm	1500mm	1800mm	2400mm	L*(277*277mm)	T*(529*277mm)	X*(529*529mm)
Diffuser	/	12W/1250LM	24W/2500LM	30W/3150LM	36W/3750LM	48W/5000LM	11W/1155LM	16W/1680LM	21W/2205LM
Microprism	/	12W/1250LM	24W/2500LM	30W/3150LM	36W/3750LM	48W/5000LM	11W/1155LM	16W/1680LM	21W/2205LM
Grating 30°	4W/300LM	12W/850LM	24W/1700LM	30W/2100LM	36W/2500LM	48W/3500LM	/	/	/
Grating 60°	4W/250LM	12W/700LM	24W/1400LM	30W/1800LM	36W/2300LM	48W/3100LM	/	/	/
Block frosted diffuser	/	12W/1200LM	24W/2400LM	30W/3000LM	36W/3600LM	48W/4800LM	/	/	/
Asymmetric	4W/500LM	12W/1500LM	24W/3000LM	30W/3750LM	36W/4500LM	48W/6000LM			
Double asymmetric	4W/500LM	12W/1500LM	24W/3000LM	30W/3750LM	36W/4500LM	48W/6000LM			
Blind cover	/	/	/	/	/	/	Available	Available	Available

### Model Number

Model	Series	Section Size	Diffuser Shape	Diffuser Nature	Carrier Style	Profile Colour	End Cap Style	Length	Light Source Type	Light Source Power	CCT	CRI	Power Type	
GCCHA-GLM25-12W-2F	Surface mounted	GLM 25	Flat	F	NO Carrier	Silver	Holeless end cap	190mm	24VDC flexible strip	12W	2700K	>80	24V DC External Driver	
GCCHA-GLM25-24W-4F			Grating	G	Micro-prism	Flat	White		600mm	24VDC Rigid module	24W	3000K	>90	
GCCHA-GLM25-30W-5F			Square	K	30°	F	Black		1200mm		30W	4000K	NW	
GCCHA-GLM25-36W-6F			Lens	L	60°	H			1500mm		36W	5000K	DW	
GCCHA-GLM25-36W-6F			Asymmetric	A					1800mm		48W	6500K	W	
GCCHA-GLM25-48W-8F			Double Asymmetric	S					2400mm					

□ Diffuser/Microprism    ▨ Grating 30°/60°    ≡ Asymmetric / Double asymmetric    □ Block frosted diffuser    ■ Blind cover

### Standard length

600mm	2400mm
1200mm	1800mm
1500mm	1500mm
1800mm	1200mm
2400mm	600mm
	190mm
600mm	2400mm
1200mm	1800mm
1500mm	1500mm
1800mm	1200mm
2400mm	600mm
	190mm

### Customised length (2400mm ~ 5000mm)

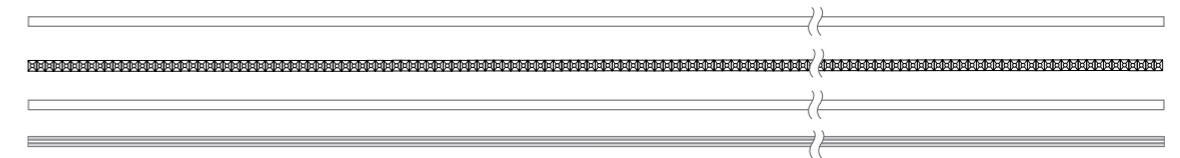

### Ultra long connection (> 5000mm)

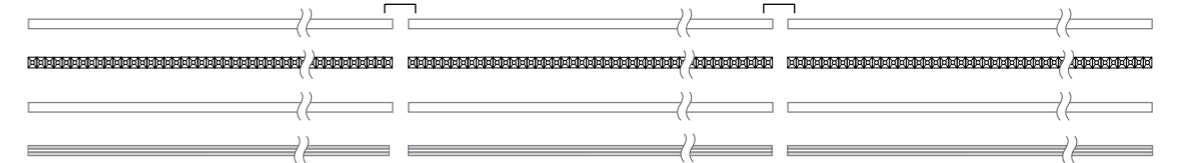

### Corners

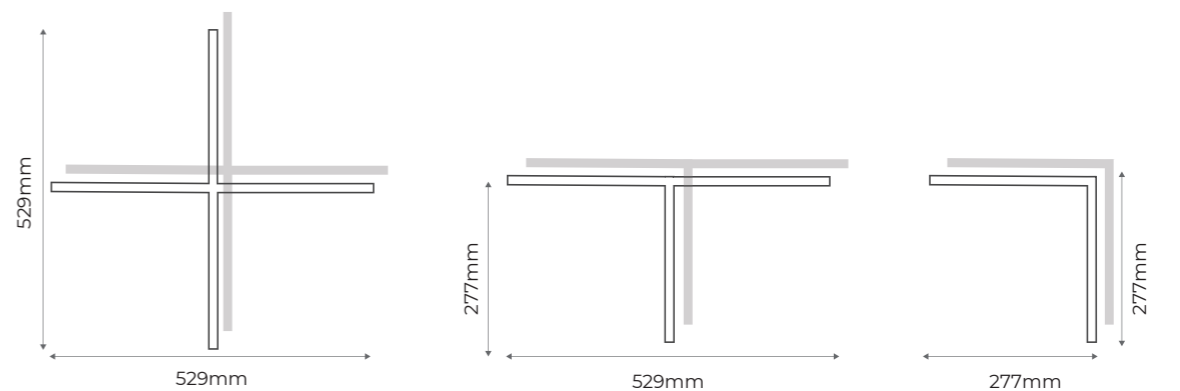

# GLE25 DC 24V

## Recessed LED Linear Light



- 25mm slender lighting surface.
- 125Lm/w high light efficiency design, lumen output up to 2300Lm/m.
- Multiple light distribution options (Diffuser, Microprism, Grating 30°, Grating 60°, Asymmetric, Double Asymmetric) to meet variety application requirements.
- Butterfly clip design, more convenient installation.

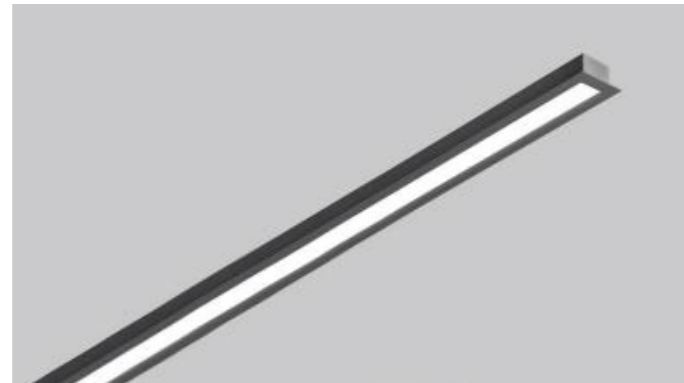
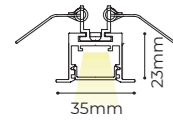

### Basic Parameters

Profile material AL6063-T5

Surface processing  Spraying RAL9003  Spraying RAL9005  Anodising

CCT  2700K  3000K  4000K  5000K  6500K

CRI Ra80/Ra90\* (\*only for 2700K/3000K)

	190mm	600mm	1200mm	1500mm	1800mm	2400mm	L*(277*277mm)	T*(529*277mm)	X*(529*529mm)
Diffuser	4W/400LM	12W/1250LM	24W/2500LM	30W/3150LM	36W/3750LM	48W/5000LM	11W/1155LM	16W/1680LM	21W/2205LM
Microprism	4W/400LM	12W/1250LM	24W/2500LM	30W/3150LM	36W/3750LM	48W/5000LM	11W/1155LM	16W/1680LM	21W/2205LM
Grating 30°	4W/300LM	12W/850LM	24W/1700LM	30W/2100LM	36W/2500LM	48W/3500LM	/	/	/
Grating 60°	4W/250LM	12W/700LM	24W/1400LM	30W/1800LM	36W/2300LM	48W/3100LM	/	/	/
Asymmetric	4W/500LM	12W/1500LM	24W/3000LM	30W/3750LM	36W/4500LM	48W/6000LM			
Double asymmetric	4W/500LM	12W/1500LM	24W/3000LM	30W/3750LM	36W/4500LM	48W/6000LM			
Blind cover	/	/	/	/	/	/	Available	Available	Available

### Model Number

Model	Series	Section Size	Diffuser Shape	Diffuser Nature	Carrier Style	Profile Colour	End Cap Style	Length	Light Source Type	Light Source Power	CCT	CRI	Power Type
GCCHA-GLE25-4W-190MM GCCHA-GLE25-12W-2F GCCHA-GLE25-24W-4F GCCHA-GLE25-30W-5F GCCHA-GLE25-36W-6F GCCHA-GLE25-48W-8F	Recessed	GLE 25	Flat	Diffuser	NO Carrier	Silver	Holeless end cap	190mm	24VDC flexible strip	4W	2700K	>80	24V DC External Driver
			Grating	Micro-prism	Flat	White		600mm	24VDC Rigid module	12W	3000K	>90	
			Lens	30°		Black		1200mm		24W	4000K	NW	
				60°				1500mm		30W	5000K	DW	
				Asymmetric				1800mm		36W	6500K	W	
				Double Asymmetric				2400mm		48W			
LLS -		GLE 25	F	D	X	S	S	2400	F	48	NW	8	X -

□ Diffuser/Microprism    ▨ Grating 30°/60°    ≡ Asymmetric / Double asymmetric    ■ Blind cover

### Standard length

190mm	□	▨	≡	■	2400mm
600mm	□	▨	≡	■	1800mm
1200mm	□	▨	≡	■	1500mm
1500mm	□	▨	≡	■	1200mm
1800mm	□	▨	≡	■	600mm
2400mm	□	▨	≡	■	190mm
190mm	≡				
600mm	≡				
1200mm	≡				
1500mm	≡				
1800mm	≡				
2400mm	≡				

### Customised length (2400mm ~ 5000mm)

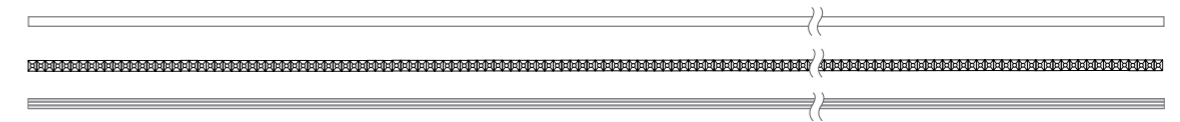

### Ultra long connection (> 5000mm)

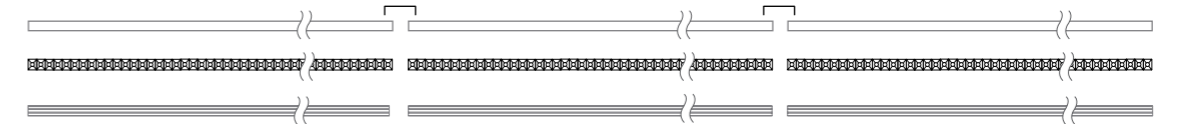

### Corners

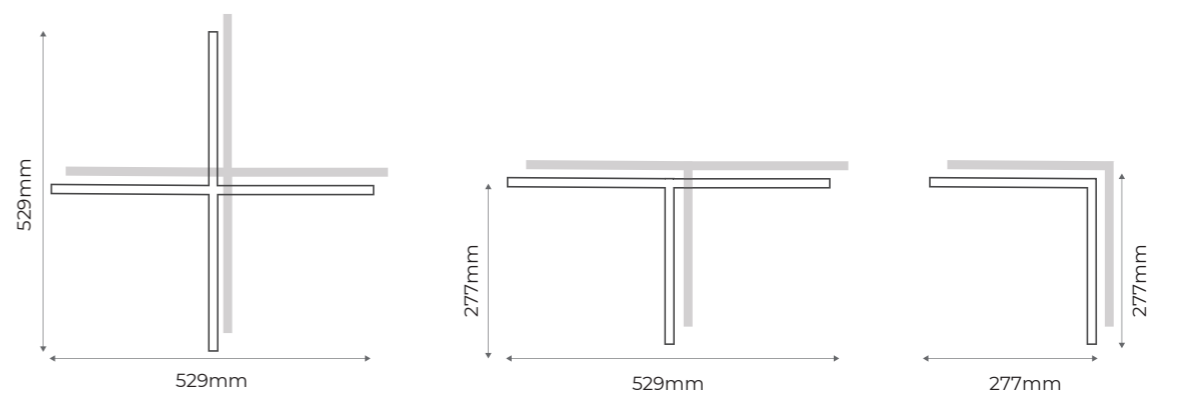

# GLR25 DC 24V

## Rimless Recessed LED Linear Light



- 25mm slender lighting surface.
- 125Lm/w high light efficiency design, lumen output up to 2300Lm/m.
- Multiple light distribution options(Diffuser, Microprism, Grating 30°, Grating 60°, Asymmetric, Black Prismatic diffuser) to meet variety application requirements.
- Rimless recessed design.

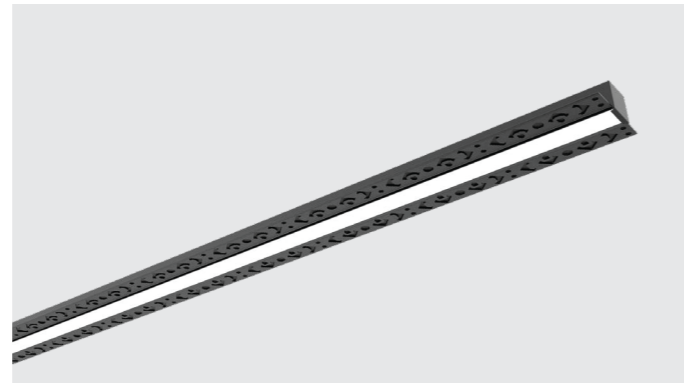
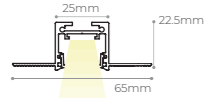

Diffuser/Microprism  
  Grating 30°/60°  
  Asymmetric  
  Black Diffuser

### Basic Parameters

Profile material AL6063-T5

Surface processing  Spraying RAL9003  Spraying RAL9005  Anodising

CCT  2700K  3000K  4000K  5000K  6500K

CRI Ra80/Ra90\* (\*only for 2700K/3000K)

	190mm	600mm	1200mm	1500mm	1800mm	2400mm
Diffuser	4W/400LM	12W/1250LM	24W/2500LM	30W/3150LM	36W/3750LM	48W/5000LM
Microprism	4W/400LM	12W/1250LM	24W/2500LM	30W/3150LM	36W/3750LM	48W/5000LM
Grating 30°	4W/300LM	12W/850LM	24W/1700LM	30W/2100LM	36W/2500LM	48W/3500LM
Grating 60°	4W/250LM	12W/700LM	24W/1400LM	30W/1800LM	36W/2300LM	48W/3100LM
Asymmetric	4W/500LM	12W/1500LM	24W/3000LM	30W/3750LM	36W/4500LM	48W/6000LM
Black Diffuse	4W/70LM	12W/210LM	24W/420LM	30W/530LM	36W/630LM	48W/840LM
Blind cover		/	/	/	/	/

### Standard length

190mm			2400mm
600mm			1800mm
1200mm			1500mm
1500mm			1200mm
1800mm			600mm
2400mm			190mm
190mm			
600mm			
1200mm			
1500mm			
1800mm			
2400mm			

### Customised length (2400mm ~ 5000mm)

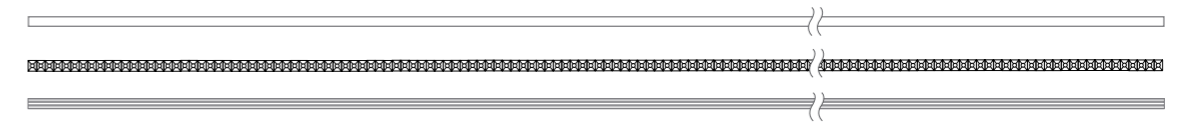

### Ultra long connection (> 5000mm)

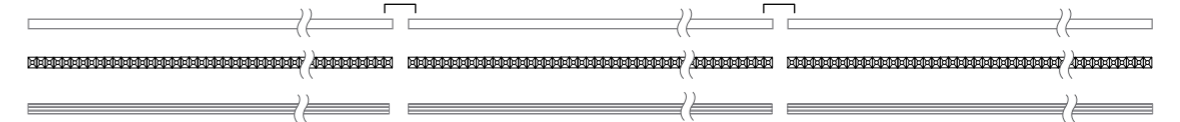

### Model Number

Model	Series	Section Size	Diffuser Shape	Diffuser Nature	Carrier Style	Profile Colour	End Cap Style	Length	Light Source Type	Light Source Power	CCT	CRI	Power Type
GCCHA-GLR25-4W-190MM	Trimless Recessed	GLR 25	Flat	F	NO Carrier	Silver	Holeless end cap	190mm	24VDC flexible strip	4W	2700K	>80	24V DC External Driver
GCCHA-GLR25-12W-2F								24VDC Rigid module	12W	3000K	>90		
GCCHA-GLR25-24W-4F									24W	4000K	NW		
GCCHA-GLR25-30W-5F									30W	5000K	DW		
GCCHA-GLR25-36W-6F									36W	6500K	W		
GCCHA-GLR25-48W-8F									48W				





GLH25 Surface mounted







GLE25



GLC25

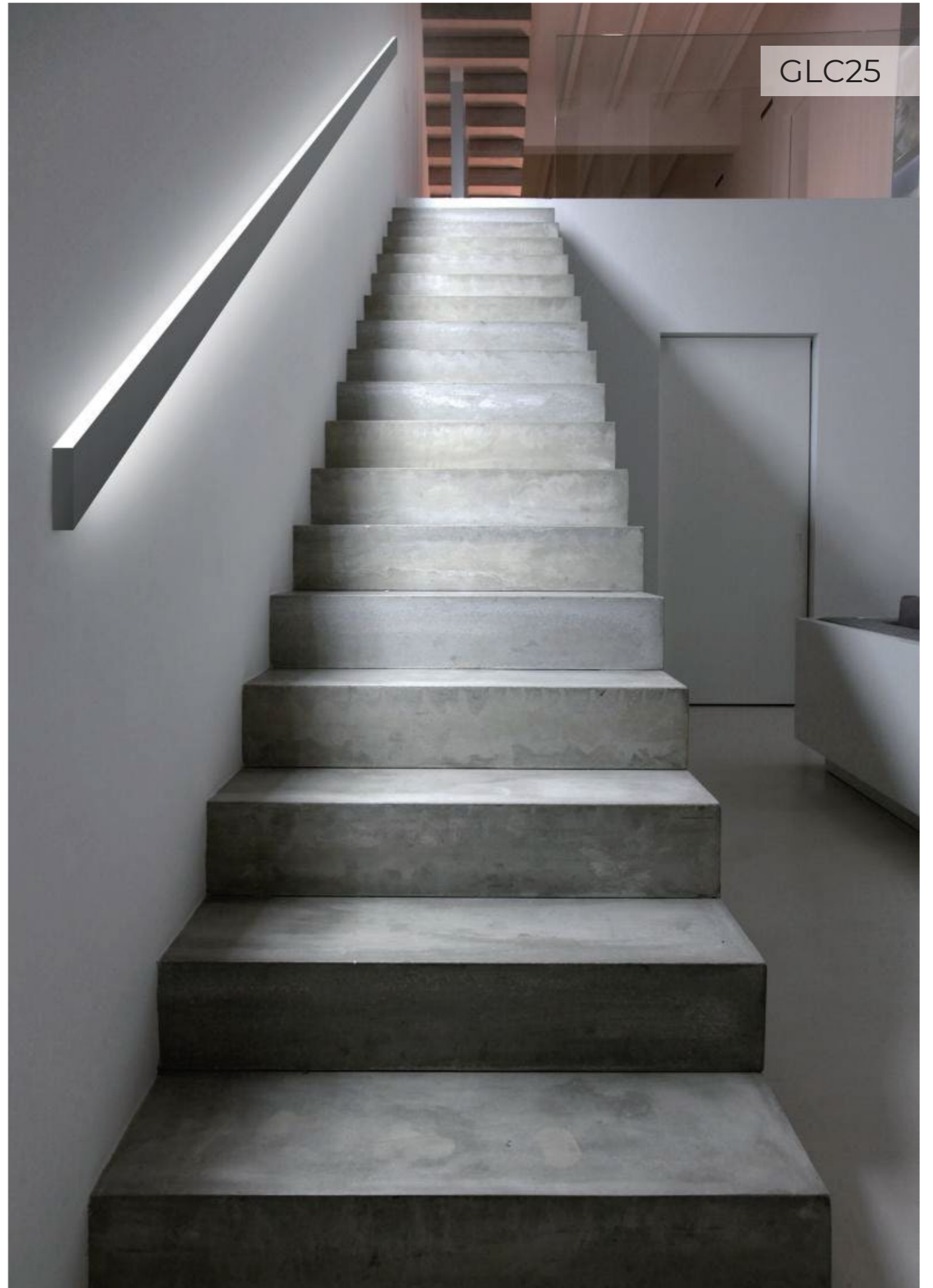





## Greenlux Lighting

37 Chelmsford Street, Williamstown North  
VIC 3016 Australia

Phone: 1300 650 625

Email: [enquiries@greenlux.com.au](mailto:enquiries@greenlux.com.au)

Website: [www.greenlux.com.au](http://www.greenlux.com.au)

